

electronics

radio, communication, industrial applications of electron tubes . . . engineering and manufacture

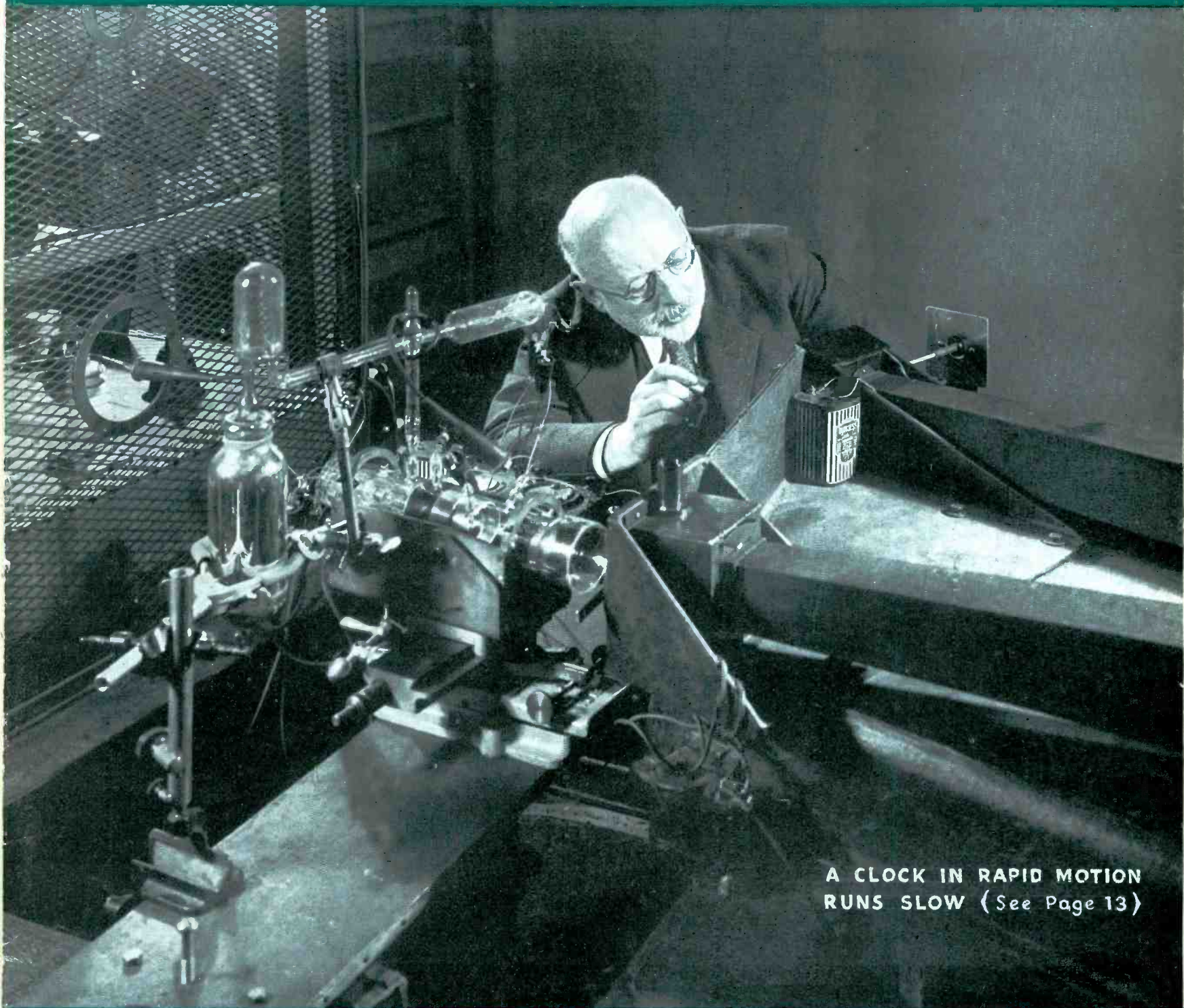

A CLOCK IN RAPID MOTION
RUNS SLOW (See Page 13)

McGRAW-HILL
PUBLISHING COMPANY, INC.

JUNE
1938

Price 50 Cents

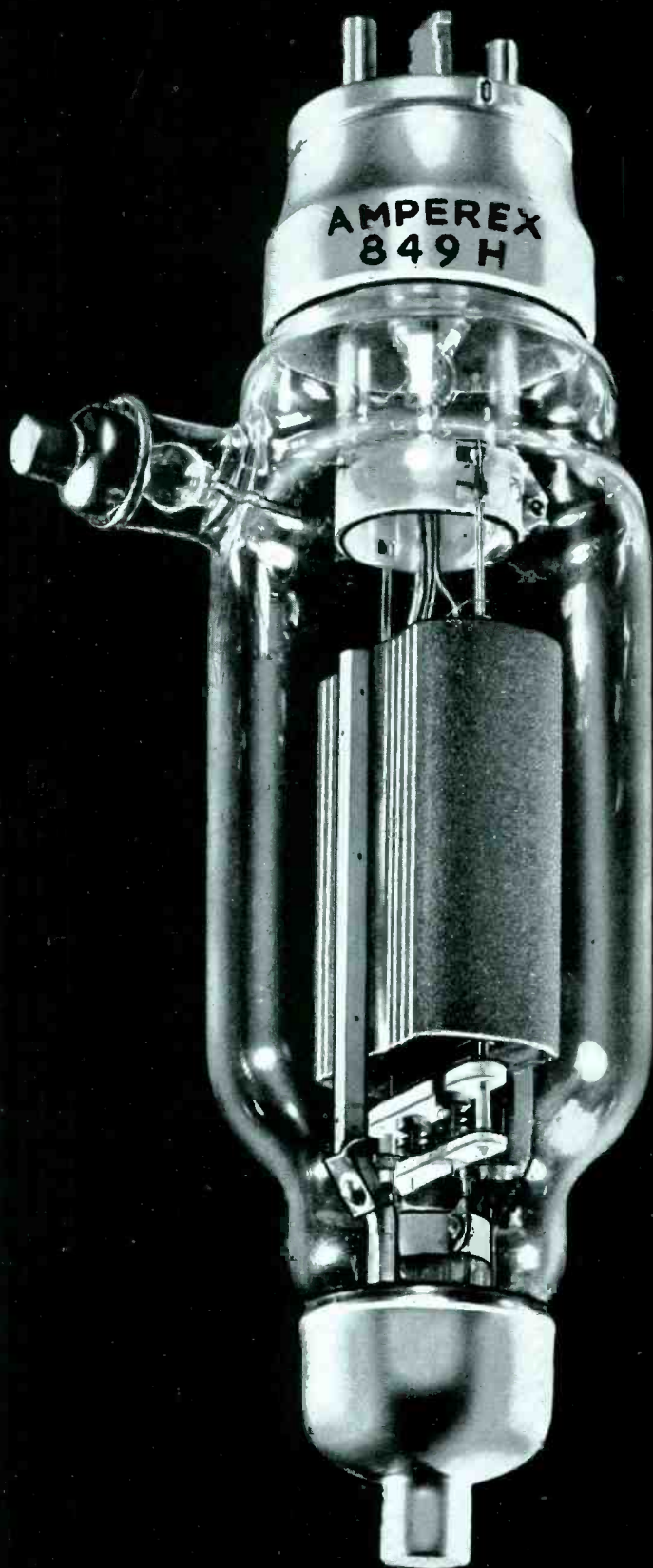

AMPEREX 849H

**A HIGH POWER—HIGH FREQUENCY TUBE
of Unusual Performance Capabilities
Can be operated at full ratings
UP TO 30 MEGACYCLES**

Specialized research by the Amperex engineering staff in the field of Ultra High Frequency has resulted in a new concept of the space relationship of the electrodes in a vacuum tube as it affects the tube characteristics.

Based on this concept a series of Ultra High Frequency tubes (the HF-100, HF-200 and HF-300) were designed. Each of them has set a new standard of efficiency in its class and all of them have one dominant characteristic in common—

a remarkably high ratio of transconductance to interelectrode capacitance.

The Amperex 849-H, recently developed in answer to the demand for greater power at high frequency, also possesses this essential characteristic.

OTHER OUTSTANDING FEATURES ARE:

- ★ LARGER FILAMENT AREA
- ★ UNIFORM HEAT DISTRIBUTION BECAUSE OF BLACK BODY AND ROUGH SURFACE RADIATION OF GRAPHITE ANODE
- ★ MINIMUM OF INTERELECTRODE INSULATING SPACERS
- ★ VERY LOW INTERELECTRODE CAPACITANCE
- ★ 750 WATTS CARRIER POWER OUTPUT, AS A PLATE MODULATED CLASS C AMPLIFIER
- ★ 250 WATTS CARRIER POWER OUTPUT AS A GRID BIAS MODULATED CLASS C AMPLIFIER
- ★ 1600 WATTS MAXIMUM SIGNAL POWER OUTPUT PER PAIR AS CLASS B A.F. MODULATOR
- ★ 250 WATTS CARRIER POWER OUTPUT AS A CLASS B LINEAR R.F. AMPLIFIER
- ★ 150 WATTS UNDISTORTED POWER OUTPUT AS, A CLASS A A.F. MODULATOR

\$135

AMPEREX ELECTRONIC PRODUCTS, Inc.
79 WASHINGTON STREET
BROOKLYN, NEW YORK

electronics



RADIO . . . COMMUNICATION AND
INDUSTRIAL APPLICATIONS OF
ELECTRON TUBES . . . DESIGN . . .
ENGINEERING . . . MANUFACTURE

KEITH HENNEY
Editor

DONALD G. FINK
Managing Editor

BEVERLY DUDLEY
Associate Editor

HARRY PHILLIPS
Art Director

H. W. MATEER
Manager

ELECTRONICS, June, 1938, Vol. 11, No. 6.
Published monthly, price 50c a copy. Subscription
rates—United States and possessions, Canada,
Mexico and Central American countries, \$5.00 a
year. All other countries, \$6.00 a year or 24
shillings. Entered as Second Class matter, August
22, 1936, at Post Office, Albany, N. Y., under
the Act of March 3, 1879.
Branch Offices: 520 North Michigan Ave., Chicago;
883 Mission St., San Francisco; Aldwych House,
Aldwych, London, W. C. 2; Washington; Phila-
delphia; Cleveland; Detroit; St. Louis; Boston;
Atlanta, Ga.

Contents Copyright, 1938, by
McGraw-Hill Publishing Company, Inc.

McGRAW-HILL
PUBLISHING COMPANY, INC.

JAMES H. MCGRAW
Founder and Honorary Chairman

Publication Office
99-129 North Broadway, Albany, N. Y.

Editorial and Executive Offices
330 West 42nd Street, New York, N. Y.

James H. McGraw, Jr., President
Howard Ehrlich, Executive Vice President
Mason Britton, Vice Chairman
B. R. Putnam, Treasurer
D. C. McGraw, Secretary
A. W. Morrison, Circulation Manager

Cable Address:
MCGRAWHILL, New York
Member A.B.P. Member A.B.C.

CONTENTS—JUNE, 1938

| | |
|---|--------|
| CLOCK IN RAPID MOTION RUNS SLOW..... | Cover |
| Dr. H. E. Ives of the Bell Telephone Laboratories whose recent discovery of the shift of spectrum of high speed hydrogen atoms reopens the question of the "ether" | |
| RHYME—WITH REASON | 12 |
| Reproduction of facsimile reception from WOR. Received in <i>Electronics</i> office with Finch recorder and Philco receiver | |
| THE ETHER—FACT OR FICTION..... | 13 |
| The question of the existence of the ether is raised again by Dr. H. E. Ives' discovery of a shift in the spectral lines produced by hydrogen ions moving at high speed | |
| WHAT'S NEW IN RADIO..... | 16 |
| New products, new ideas which will be used in this season's radio sets | |
| TELEVISION RECEIVERS—II, by E. W. Engstrom and R. S. Holmes | 20 |
| A continuation of the educational discussion begun in the April issue. R-f and i-f circuits are described | |
| ELECTRONIC AIDS IN SALES PROMOTION, by Bernard Ephraim | 24 |
| Use of tubes and tube circuits as an aid to promoting business | |
| I. R. E. CONVENTION PROGRAM..... | 26 |
| What radio engineers will discuss at the Hotel Pennsylvania this month | |
| HELEN KELLER IS INTRODUCED TO TELEVISION..... | 27 |
| Miss Keller attends <i>Electronics'</i> demonstration of television performance from N. B. C. | |
| RECTIFIER FILTER DESIGN, by Herbert J. Scott..... | 28 |
| Graphical design of smoothing filters for various common rectifier circuits | |
| TABLE OF LC PRODUCTS AND THEIR LOGARITHMS..... | 31 |
| LC products for the most commonly used frequencies, computed to six significant figures | |
| I.R.E. WORLD CONFERENCE HELD IN AUSTRALIA..... | 33 |
| Men who attended I. R. E. (Australia) meeting in Sidney | |
| POWER TUBE CHARACTERISTICS, by E. L. Chaffee..... | 34 |
| Cathode ray tube used to trace out characteristics of power tubes | |
| AN INPUT SWITCHING CONSOLE, by J. B. Epperson..... | 38 |
| Convenient switching and control desk for broadcast use | |
| W. R. WHITNEY RECEIVES NATIONAL ACADEMY AWARD.... | 42 |
| Recognition accorded G. E.'s Research Director | |
| DEPARTMENTS | |
| CROSSTALK | 11 |
| BOOK REVIEWS | 59, 90 |
| REFERENCE SHEET | 31 |
| TUBES AT WORK | 44 |
| ELECTRON ART | 60 |
| MANUFACTURING REVIEW | 80 |
| PATENTS | 91 |
| INDEX TO ADVERTISERS | 96 |

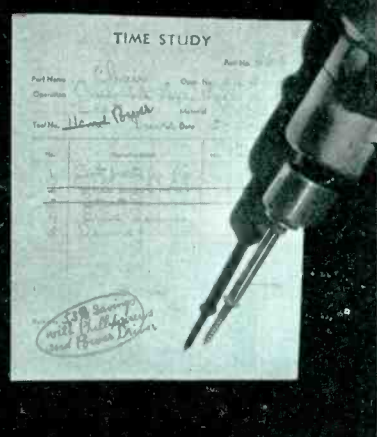

HOURS SAVED

Gain Time



WITH THE NEW

WORK LIGHTENED

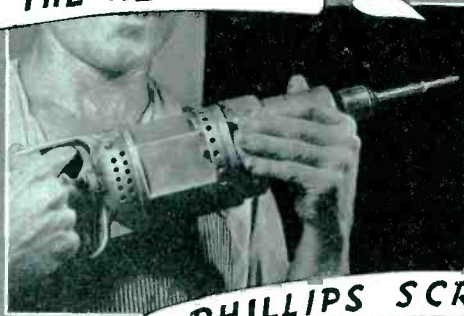

Guides Driver



PHILLIPS SCREW

NEATER DESIGN



Guard Work

A recessed head screw that clings to the driver's point . . . takes half the effort to drive . . . won't let the driver slip out . . . *that's* the screw that will reduce fastening costs in your plant.

Take the matter of *time*. The Phillips Screw with the *recessed* head *gains* hours per day. One-hand starting and driving. Use a faster driving method — there's no danger of slipping. Eliminate operations — like removing burrs or split heads.

And ease of driving. The Phillips Screw guides

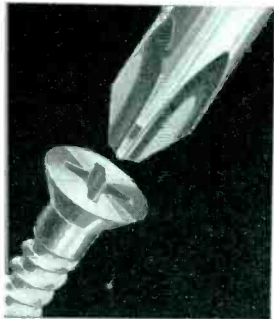

This is the Patented Phillips Recessed Head

Note the tapered recess in the screw head — its angle was worked out after months of tests to learn how to utilize the driver's maximum turning power. Note the flat surfaces — no curves except at the rim. That prevents the driver from burring the screw. Machined to tolerances of plus or minus .001" — to guarantee a perfect fit. Hand, spiral or power drivers may be used — available from several manufacturers and distributors.

the driver — one hand is free for holding the work. Use half the effort, because there's three times the contact between driver and screw. Men — less tired — do better work . . . fewer seconds.

And *quality*. The Phillips Screw *guards* the work. The driver can't slip out and scar the surface (or the hands). Better holding power against vibration, too, because it sets up much tighter, flush with the surface.

Get a jump on *your* industry with the Phillips Screw with the patented recessed head, which *gains* time, *guides* driver, *guards* work. Fill out the coupon and send to one of the firms below for Folder A, giving helpful information on what the Phillips Screw can do for you. No obligation.

PHILLIPS SCREWS

Gain Time . . . Guide-Driver . . . Guard Work

MACHINE SCREWS

SHEET METAL SCREWS

WOOD SCREWS

STOVE BOLTS

U. S. Patents on Product and Methods Nos. 2,046,343 2,046,837 2,045,839 2,046,840 2,082,085 2,084,078 2,084,079 2,090,338
Other domestic and foreign patents allowed and pending

Manufactured by

American Screw Co., Licensor, Providence, R. I.
Continental Screw Co., New Bedford, Mass.
Corbin Screw Corp., New Britain, Conn.

National Screw & Mfg. Co., Cleveland, Ohio
Parker-Kalon Corp., New York, New York
Russell, Burdall & Ward Bolt & Nut Co., Port Chester, N.Y.

SEND THIS COUPON TO ONE OF THE FIRMS LISTED AT RIGHT — FOR SPECIFIC FACTS ON PHILLIPS SCREWS — NO OBLIGATION.

Name _____

Company _____

Address _____

We Promised *Efficiency*
 We Promised *Economy-*
 and **CFAC**
 got both!

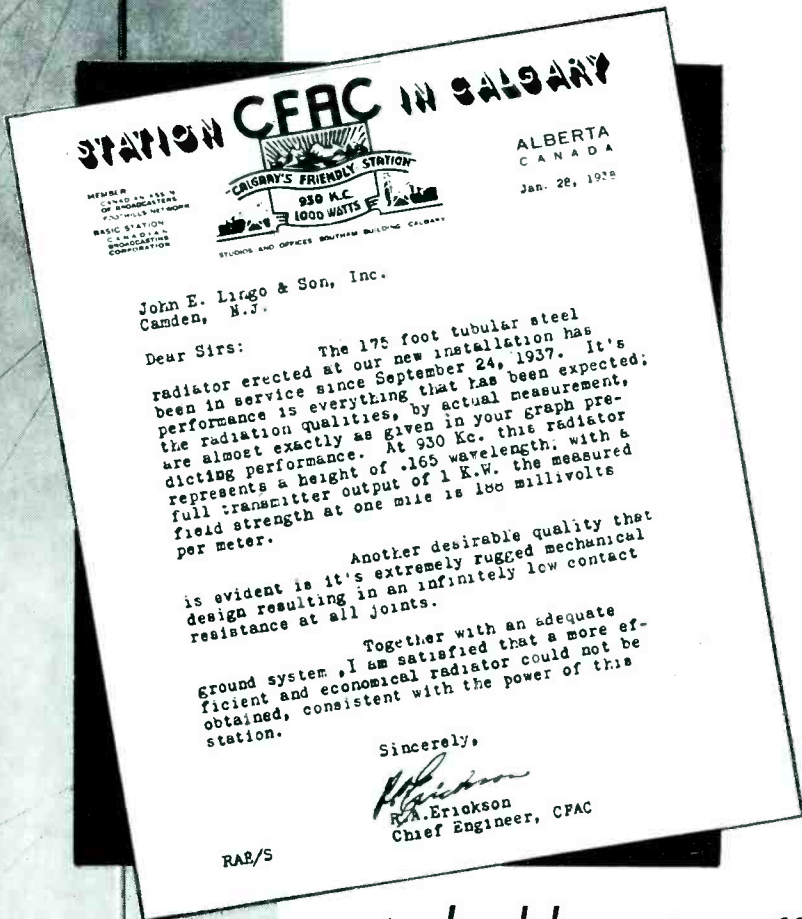

The increased efficiency and the lowered costs that Lingo promises are *once again* PROVEN FACTS . . . based on the excellent performance of the Lingo Tubular Steel Radiator recently installed at station CFAC, Calgary, Alberta.

R. A. Erickson, chief engineer writes, "I am satisfied that a more efficient and economical radiator could not be obtained". Mr. Erickson is one of several progressive engineers who have told this same story . . . a new realization of peak performance. It's a story of lowered costs and new standards that will interest YOU, too!

A double saving effected by lower height

This installation proves that with the Lingo Tubular Steel Radiator the height can be considerably less than usually required and that the field strength is much higher than the minimum requirements. The CFAC radiator pictured here is only 175 feet high (equivalent to but 1/6th wave length tall for the frequency of 930 KC). Naturally, this effects a great saving in cost, not only on the low basic price of Lingo Radiators, but also because it is possible to use a shorter Radiator than usually required.

WRITE FOR THIS FOLDER TODAY—

Free The entire amazing story of Lingo Vertical Tubular Steel Radiators. Today—write for your copy of our brochure—"NEW STANDARDS FOR VERTICAL RADIATORS". Gladly sent to executives and engineers.

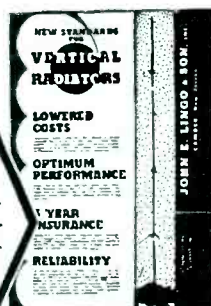

John E. Lingo & Son, Inc.
 CRAMER HILL
 CAMDEN, N. J.

LINGO

VERTICAL Tubular Steel RADIATORS

Dependable **LENZ** Cable

CONTRIBUTES TO THE DISTINCTIVE PERFORMANCE OF THE

NEW BELMONT AUTO RADIO

DEVELOPED with the cooperation of Mr. William Dunn, Chief Engineer, and Mr. Pat D'Orio, Ass't. Chief Engineer of Belmont, Lenz New Auto Radio Cable is outstanding for its stability.

WE'RE proud to say that Lenz Cable was selected for the NEW Permeability - Tuned BELMONT Auto Radio and contributes its bit to the superlative performance of this receiver. Especially developed by Lenz with the cooperation of Mr. William Dunn, Chief Engineer of Belmont, it utilizes a new insulation of extremely high "Q" that will permanently maintain its electrical characteristics. This is a typical example of Lenz ability to give you cables with just the characteristics you need for your sets.

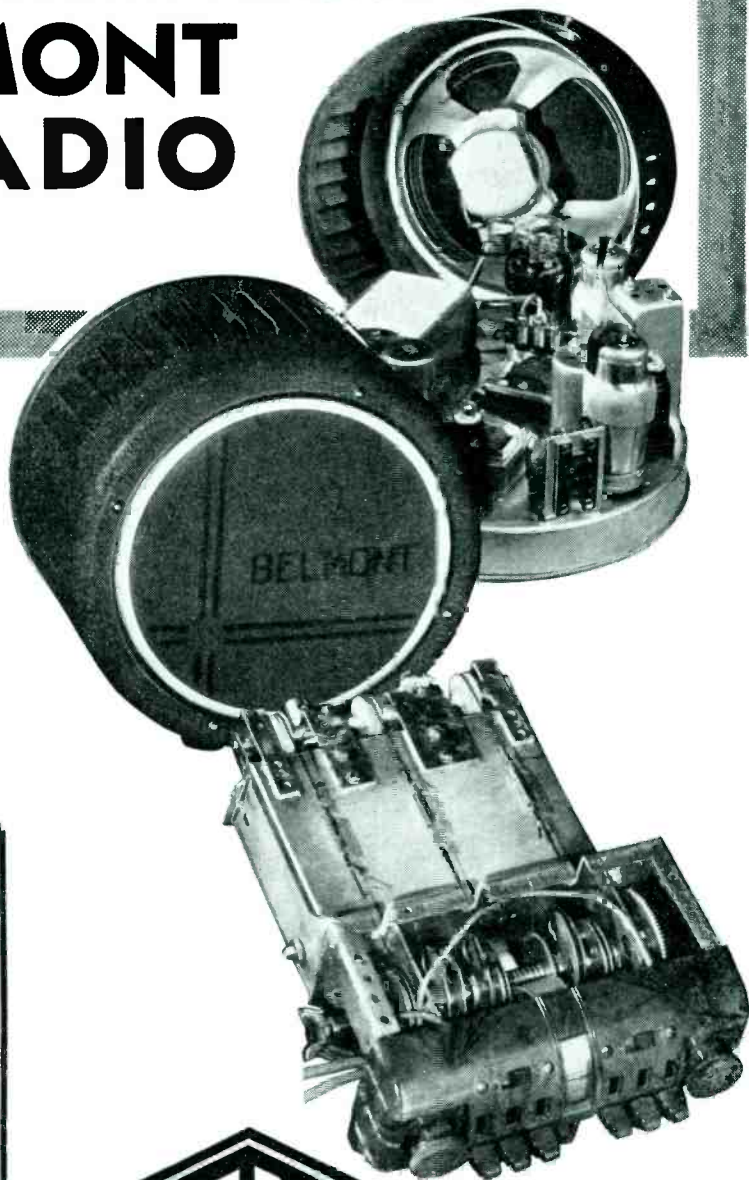

TELEPHONES
LINCOLN 5080

CABLE ADDRESS
BELRAD

BELMONT RADIO CORPORATION

1257 FULLERTON AVENUE
CHICAGO, ILL. U.S.A.

June 1, 1938

Mr. R. G. Zender, Sales Manager
Lenz Electric Manufacturing Co.
1751 North Western Avenue
Chicago, Illinois

Dear Mr. Zender:

I wish to take this opportunity to express my appreciation for your splendid cooperation in the development of the Belmont Auto Radio tuner cable. This cable meets our requirements in every way and contributes materially to the performance of our Permeability Tuned Receiver.

Yours very truly,

BELMONT RADIO CORPORATION

W. L. Dunn
Chief Engineer

WLD:VT



LENZ ELECTRIC MFG. CO.

1751 No. Western Ave., Chicago, U.S.A.

IN BUSINESS SINCE 1904

FOCALIZATION

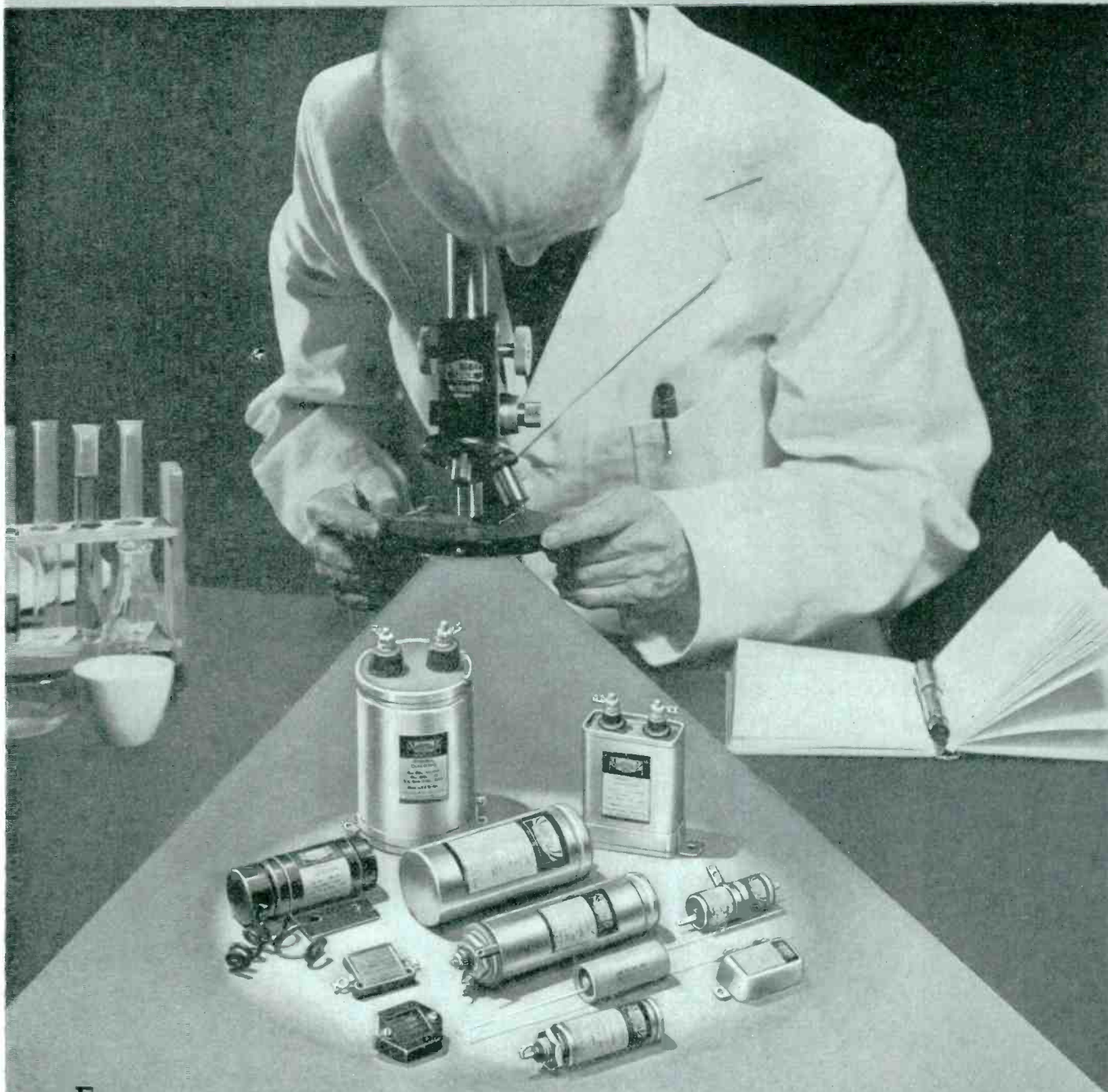

For over a quarter of a century, the combined efforts and ingenuity of Cornell-Dubilier have been focused on the production of capacitors—and capacitors alone. This focalization of research and manufacturing experience is directly responsible

for the production of dependable capacitors. Today, Cornell-Dubilier offers the greatest values obtainable in capacitors for every radio and electrical need. Get to know C-D's. Write for Catalog No. 160, free on request.

Products of the world's oldest and largest exclusive manufacturer of capacitors

CORNELL - DUBILIER ELECTRIC CORP.
1000 Hamilton Boulevard, South Plainfield, New Jersey

STAMP IT

PUNCH IT

DRILL IT

MACHINE IT

XPLW for

Still **HIGHER Fidelity**

--- Those are the "call letters" of Low Power Loss **DILECTO**—a special grade of phenolic laminated insulation developed especially to meet the remarkable advances in radio and television performance. **Dilecto XPLW** has an unusually low power factor and outstanding stability of electrical properties under the most severe conditions of service. Its dielectric strength is unusually high and its mechanical properties permit easy and accurate machining, punching and drilling. Write for samples.

CONTINENTAL-DIAMOND FIBRE CO.
NEWARK, DELAWARE

DILECTO

CINCH



ACTUAL SIZE

"Cinch" shielded connector unit (left); plug No. 2050 fitted with .00015 to .00025 mmf condenser.

Note convenient soldering area, also large contact surface on split sides of plug No. 2042.

This unit consists of plug No. M93, shell No. 1144 and connector No. 2811—midget size; will pass through a $1\frac{3}{32}$ " diameter hole and is $1\frac{3}{4}$ " long.

Plug is provided with a drawn shoulder to which the external cable shielding is soldered. Supplied with either .125" or .156" diameter standard tube prong. The connector base No. 83 is riveted to and becomes part of the chassis with the same riveting operation that attaches the socket.

Consider these advantages (a) vibration-proof electrical contact; (b) complete metal shielding of lead-in wire through solder joints and wiping contacts direct to chassis (c) with complete grounding.
 "Cinch" and Oak Radio Sockets are licensed under H. H. Eby Socket pats.

CINCH ANTENNA SHIELDED CONNECTORS GIVE POSITIVE AND CONSTANT CONTACT

Here are connectors completely shielded with positive connections—for every need. Developed by Cinch to meet the most rigid requirements as a means of providing a constant electrical connection, even when subjected to the most severe vibration.

Features in each connector shown give specific advantages—making Cinch connectors invaluable. Send for prices and samples.



CINCH

MANUFACTURING CORPORATION
 2335 WEST VAN BUREN STREET, CHICAGO, ILLINOIS
 SUBSIDIARY OF UNITED CARR FASTENER CORPORATION, CAMBRIDGE, MASS.

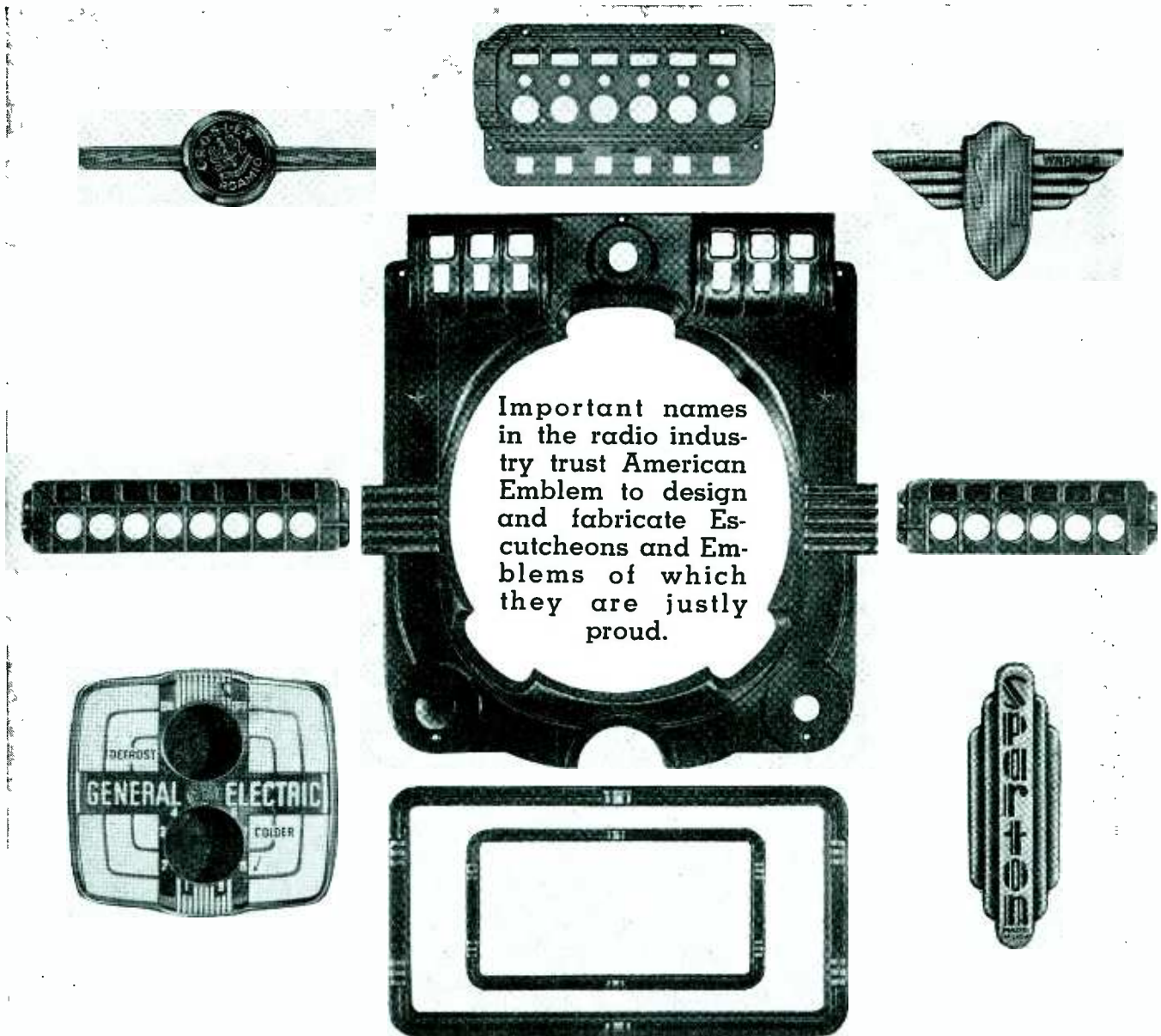

Important names
in the radio indus-
try trust American
Emblem to design
and fabricate Es-
cutcheons and Em-
blems of which
they are justly
proud.

"A.E." Offers a New Service

THE purchase of a business in Chicago places us in a still more favorable position to meet the requirements of radio designers and engineers. In addition to our recognized ability to produce top quality decorative stampings we can now supply set manufacturers with DIALS, DIAL SCALES, COMPLETE DIAL MECHANISMS and MOLDED CRYSTALS. If your plans call for receivers with improved performance and appearance without increase in production costs we will be glad to quote on your specifications.



Illustrated above is a new A.E. Slide Rule Gear Drive as supplied to Wells-Gardiner.

AMERICAN EMBLEM COMPANY, INC.

BOX 116L, UTICA, NEW YORK

BRANCH OFFICES

540 N. Michigan Ave.,
Chicago, Illinois
725 Mateo Street,
Los Angeles, Cal.

500 Fifth Ave.
New York City
710 Stephenson Bldg.
Detroit, Michigan

11 W. Monument Bldg.,
Dayton, Ohio
401 N. Broad Street,
Philadelphia, Pa.

Q U I E T

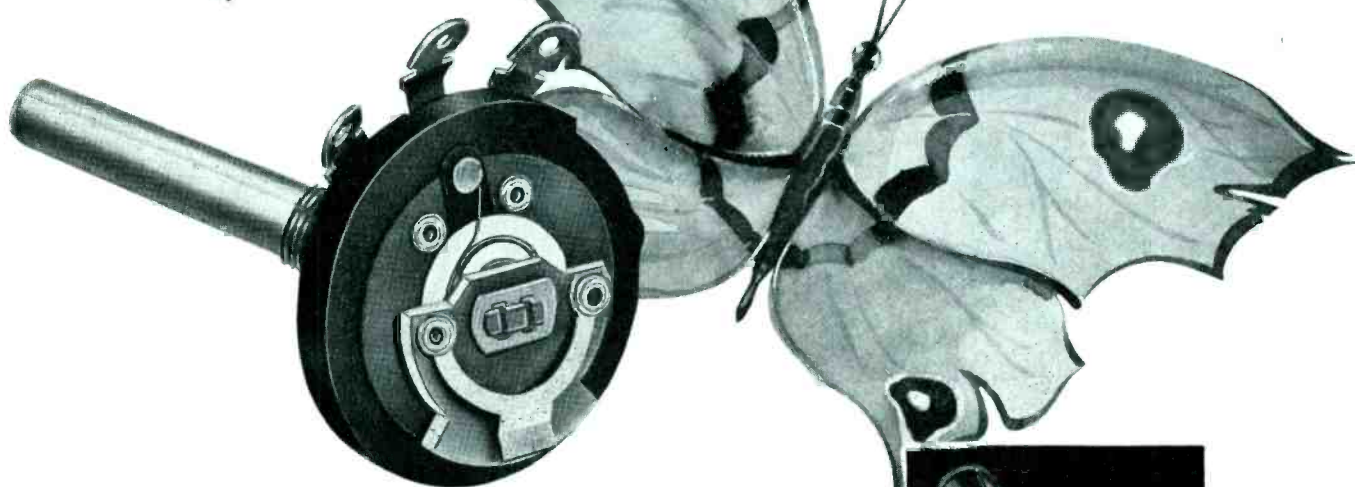

STACKPOLE

Spiral Lead

VOLUME CONTROL

All noise traceable to the collector ring of volume controls has been completely eliminated by the Stackpole Spiral Lead. In place of a metal-to-metal bearing surface affected by wear, dirt and oxidation of both metal and lubricant, the Spiral Lead provides an unbroken electrical connection between center terminal and element contact. Pressure adjustments on contacting surfaces of collector ring are unnecessary and only the shaft itself requires a lubricant.

With definite improvement in your receivers' performance assured by this Stackpole product its low price comes as a pleasant surprise. . . . Write us today for a testing sample and quotations.

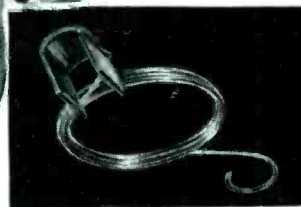

SPIRAL LEAD



INSULATING WASHER



SPACING WASHER



HEAD



SHAFT

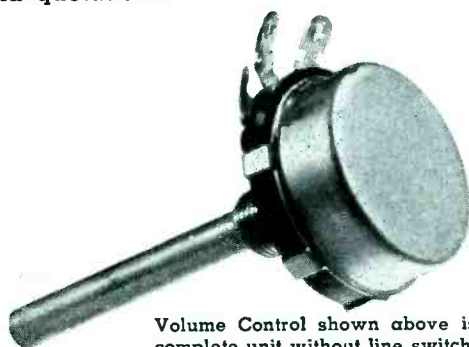

Volume Control shown above is complete unit without line switch, line switch may be attached.

STACKPOLE CARBON COMPANY

ST. MARYS, PENNSYLVANIA



MULTIPLE CIRCUIT PUSH BUTTON SWITCHES *for Varied Electronic and Industrial Applications*

- Intercommunicating Systems
- Signalling Devices
- Business Machines
- Electrical Tabulating Equipment
- Machinery Control
- Program Distribution Systems
- Public Address Amplifiers
- Microphone and Input Switching, and Equalizer Network Switching in Broadcast or Telephone Equipment
- Signal Generators and Test Oscillators
- Tube Testers and Servicing Instruments



—and many other applications where it is necessary to close several circuits and automatically open any previously closed circuits.

In addition to its great flexibility in radio receiver design for station selection and wave band switching, the Mallory-Yaxley Type MC Switch provides additional features that adapt its operation to varied industrial applications. The sliding contact shoes may be specified to accomplish either shorting or non-shorting

switching sequence. A maximum of 16 terminals per plunger provide an endless variety of switching combinations. Side-acting, non-critical latch bar allows inter-connection of switch groups. An AC power line switch may be specified to operate from either end plunger. Write for specification sheet and complete information.

YAXLEY MFG. DIVISION OF P. R. MALLORY & CO., INC., INDIANAPOLIS, INDIANA

Cable Address—PELMALLO

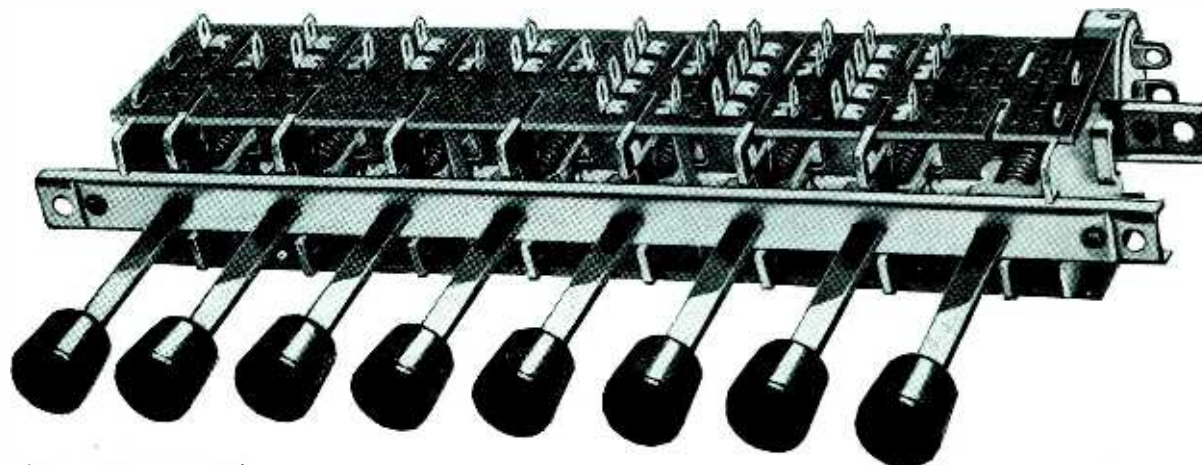

(PAT. APPLIED FOR)

ELECTRONICS

JUNE
1938



KEITH HENNEY
Editor

Crosstalk

► **OR ELSE . . .** Many radio listeners still complain of the fact that the broadcast system is supported by paid advertising. Certain representatives of the people seem to feel that there is something morally wrong about a private profit being made out of a public wavelength.

But all the profits of broadcasting are not money profits. The millions of listeners daily accumulate, collectively, far greater profits than all those who own and operate the stations. Can Americans, even congressmen, never get away from estimating values in terms of dollars?

There is, of course, an alternative. In Great Britain there is no commercialism on the radio. From all reports the BBC runs the broadcasting set-up much better than any politically minded body could be expected to run our broadcast system. And yet a poll made by Philco among some half-million listeners in England gave first place in popularity to Luxembourg, and second place to Athlone in the Irish Free State. Both of these stations operate on the American plan of paying for programs by advertising. Third place was the non-commercial English station at Droitwich.

The alternative to private ownership and operation of broadcast stations under government regulation is government ownership and operation under its own regulations. "Government", as we see it, is head-in-the-sand word for politics. What kind of profits would accrue in such a system? Profits in education, in entertainment, in dollars,—or in propaganda?

► **TELEVISION . . .** All hands were startled, late in May, by the announcement that cheap television receivers would soon be available. Using inexpensive oscillograph tubes, receivers listing at \$125 for a 3 inch tube (two-inch picture) and somewhat higher for a 5 inch tube set, were on demonstration at Mecca Temple.

On the afternoon of May 17 execu-

tives, chief editors of some 25 McGraw-Hill publications witnessed one of the NBC-RCA demonstrations to the press. This audience looked in on *Electronics* own receiver. The show was all studio-made; transitions from one set to another, from studio to film and back again, were smooth and the whole hour's program presented a finished effect. Only a few nights before this demonstration, the editors were honored by the presence of Miss Helen Keller to whom the March of Time film and "Sauce for the Gander" were described by the manual alphabet by her companion, Miss Polly Thompson. Miss Keller remarked that "everything seems to be here but the smell".

► **DATA BUREAU . . .** After many years of relying upon various members of the radio industry to compile data of technical nature, and to make certain measurements of interest to the

industry, RMA has established its own Data Bureau which is to collect technical facts about current models of radio receivers, make reservations for tube numbers, release preliminary information on new tubes, and perform other highly useful activities. This bureau will be under the direction of L. C. F. Horle, a consulting engineer widely known in radio circles. This bureau will thereby divorce considerable RMA work from the staff of the RCA License laboratory and centralize it at 90 West Street, New York City.

► **ORPHEON . . .** Good friend McMurdo Silver takes us to task for not mentioning that his Orpheon receiver was really the first of the current small crop of radios designed to receive local programs with superior fidelity, and not the Victor Symphony model as mentioned in April *Electronics*. We are happy to report that both receivers are selling well, and may live to refute all past statements that this type of set simply would not take hold.

► **PERVEANCE . . .** On the back cover of May *Electronics*, RCA described the new 833 tube stating that it had "high perveance construction." In case, you don't know what perveance is, you will find an explanation in *Electron Art*, this month. Briefly, it is the bugger factor K , in the expression for space current $I_p = KE_p^{3/2}$.

► **STEREO . . .** World traveler George Lewis, I T & T Co., sends from Antwerp two-color views of Radiobell's receiver factory and with the views came a pair of spectacles with one green eye and one red eye. Most remarkable three-dimensional effects are thereby secured of the "onze kabelmakeru", the "zicht der schrunwerkeru" etc. He also sent a very beautiful maintenance bulletin of the International Standard Electric Corporation, the subject being telephone type rotary selector switches. Here, too, the halftones are in several colors, although not arranged for stereo.

A Memorandum from VIRGIL M. GRAHAM

to Keith Henney DATE 3/10/38

You should see what the Swedes say about you!

"Välkänd inom radiokretsar är Keith Henney, redaktör för »Electronics», vilken löses av alla radioingenjörer"

Populär Radio
Februari 1938

MJ

Compliments of THE GRAY PRINTING COMPANY, of DuBois, Pa.

RHYME - WITH

Come—rest, you weary gentlemen,
 And ladies likewise weary—
 If you dismay this April day
 Drop us a *Aasty* query.

Consider WOR's recordings
 Priced as sweet as slumber;
 True of line . . . so extra fine
 And made in *any* number.



mirrored text from the reverse side of the page, including the phrase "The job we have to offer."

THE REASON

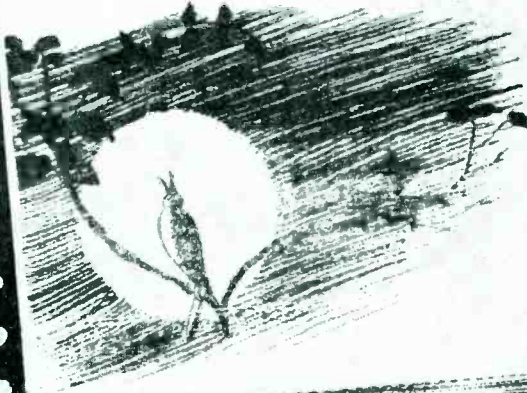

For what avails the summer rose;
 The ball park's knotted boardings,
 If to your ear the sour notes rear
 From not-so-good recordings?

O, clip this ad and hold it;
 Place it top among your hoardings,
 For come the day you'll surely say:
 "Make *mine* WOR recordings!"

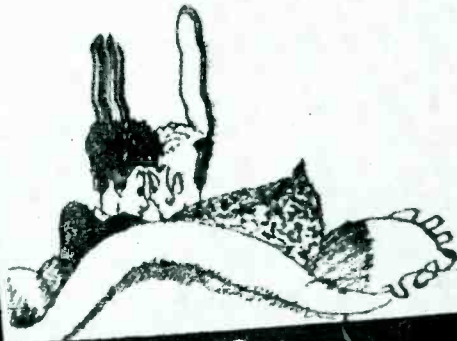

WOR
 RECORD TRANSCRIPTION AND REPRODUCTIONS
 SERVICE
 1140 Broadway, New York

Facsimile received on Finch recorder from WOR in Electronics editorial offices at 2:15 a.m., May 7. A medium priced Philco receiver was used. Loss of synchronism at the receiver caused reversed lines shown

The Ether—Fact or Fiction?

Dr. Herbert E. Ives of the Bell Laboratories, experimenting with the spectra produced by high-speed hydrogen ions, uncovers new evidence in the ether controversy, revives the possibility that the ether may be a reality after all

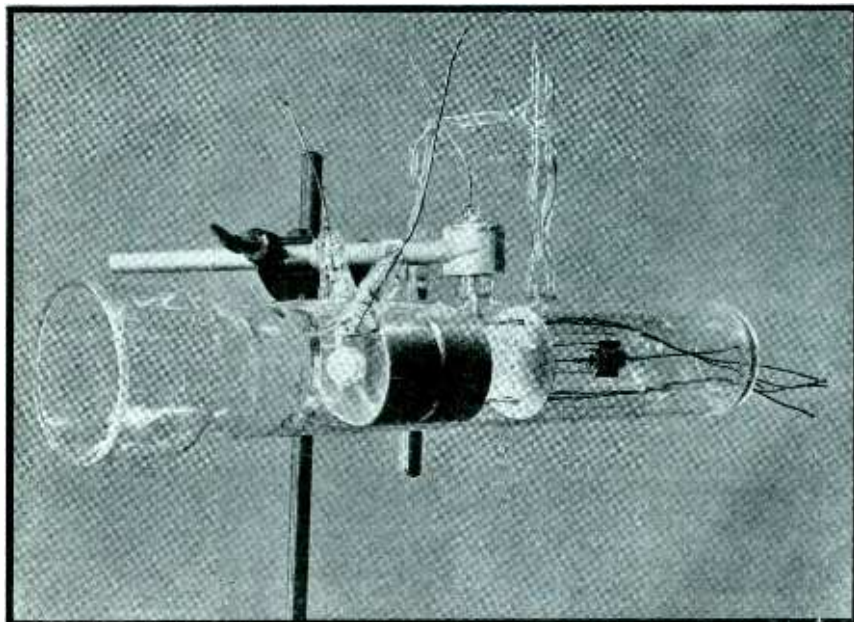

Electronic technique applied to pure research: canal-ray tube used by Dr. Ives in proving that a moving clock runs slow

THE question whether the ether, that strange medium in which radio waves and other forms of radiant energy are supposed to travel, is a fact or a fancy has been dormant for many years. Mathematical physicists have argued that the ether is a fiction, pure and simple. The engineer, whenever called upon to explain the passage of energy through space, usually makes use of the ether because it is a convenient device, and because no other explanation can be said to have any engineering significance.

Now comes word that the question of the ether's existence has been raised again, this time by the physicists. The occasion was the paper delivered by Dr. Herbert E. Ives of the Bell Laboratories, before the National Academy of Sciences on April 25th. In brief, what Dr. Ives reported was this: that hydrogen ions moving at high speeds produce light of longer wavelength than ions at rest. Stated differently, since wave-

length and frequency are inversely proportional, the radiant energy produced by high-speed ions has a lower frequency than that produced by stationary ions. Now the frequency of the light radiated by ions has long been accepted as a standard of time. Hence if the mere fact of motion reduces the frequency produced by the ion, that is, if a moving clock runs slow compared with a stationary one, it may be argued that time is relative. The difference in clock rate is extremely small unless the speed of the ions is an appreciable fraction of the speed of light.

The existence of this "slowing down" effect had been predicted on theoretical grounds some 25 or 30 years before Dr. Ives succeeded in proving it. The story goes back to the famous "ether-drift" experiments of Michelson and Morley. Michelson and Morley set up elaborate equipment for measuring the speed of light to a very fine degree of precision. They measured the speed of two

light beams, one traveling along the line of the earth's rotation around the sun, the other at right angles to this line. They found that the speed of both beams was, within the narrow limits of their experimental error, the same. This was an extremely interesting result. For the light was assumed to be traveling in the ether, and the ether was thought to pervade all space. If the ether is stationary in space then the earth drifts through it, and the speed of light traveling in the direction of the earth's motion should be slower than the speed of light traveling at right angles to the earth's motion. Since the two speeds were observed to be the same, the inference was that the ether moves with the earth. This seemed to be extremely unlikely, since if the ether moves with the earth it must be moving past all other celestial objects, and there was no reason to single out the earth for the honor of a stationary ether.

Two alternatives presented themselves. The first was to do away with the ether altogether. This answer to the problem had two points in its favor: First, Michelson and Morley had discovered no evidence of ether drift, and second, the ether itself was a very cumbersome medium to imagine. Experiments with ordinary elastic media had shown that the speed of waves through the medium depends on the square root of the elasticity of the medium divided by its density. The speed of the waves in ether, (the speed of light) is about 3×10^{10} cm./sec. The medium is obviously very rarified, since it cannot be detected, and its density must therefore be low. The rigidity of the material must therefore be correspondingly very great, many more times rigid than the hardest tool steel. That such a rigid medium could exist without giving

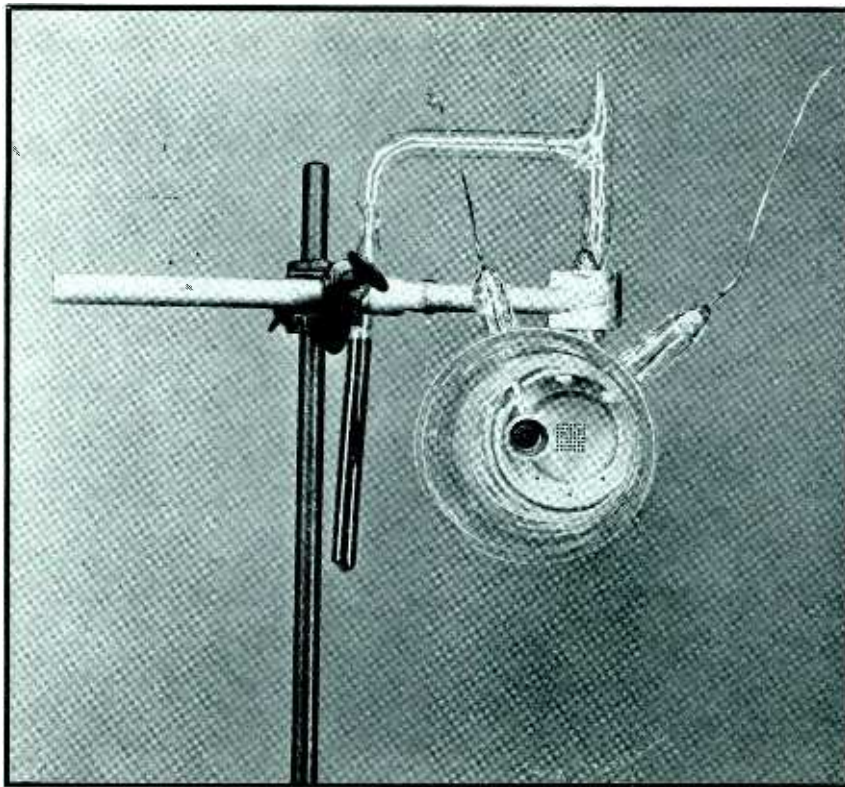

View of the tube structure through the observation window. Note perforations in plate and mirror which reflects light to window

many evidences of its presence seemed hard to imagine. So it was convenient to do away with it altogether.

But this was not the only possibility. An ingenious Irishman by the name of Fitzgerald suggested that the total lack of evidence of ether drift might be explained by inherent defects in the measuring tools employed by Michelson and Morley. In measuring the speed of light, it was necessary to measure distance and time, the quotient of the two being the velocity measured. If the length of the measuring rod decreased when it was lined up along the direction of the earth's motion, and if the clock used to measure time slowed down when it was moving in that direction, then any change in the speed of light would be offset by the changes in the measuring instruments, and no ether drift could be detected. Working from the value of ether drift to be expected, the percentage contraction of the measuring rod should be

$$\sqrt{1 - \frac{v^2}{c^2}}$$

where v is the velocity of the apparatus and c is the velocity of light. Likewise the percentage slowing down of the clock rate should be the same.

Many attempts to verify experimentally these contractions in length and clock-rate have been made. Dayton C. Miller of the Case School of Applied Science reported small positive effects in a repetition of the Michelson-Morley experiment which would suggest that the contraction was smaller than that indicated by the expression above, but other experimenters have repeated the null result. So the Fitzgerald contraction, and its more detailed embodiment in the Lorentz-Larmor theory of optics, have remained without positive proof. If we assume an all-pervading ether stationary in space, then the Michelson-Morley results prove the Fitzgerald contraction, but only in a negative way. A positive proof seems to be forthcoming from Dr. Ives' work.

Details of Dr. Ives' Experimental Equipment

The equipment used by Dr. Ives is an object lesson in the application of modern electronic technique to the problems of pure science. A brief description of the equipment follows.*

The heart of the apparatus is a specialized type of canal-ray (positive ion ray) tube, patterned after

* Dr. Ives paper, containing complete details, is to appear in July issue of the *Journal of the Optical Society of America*.

a design of A. J. Dempster, of the University of Chicago. The tube, shown in the illustration, contains an oxide-coated filament, and two perforated plates, the latter being separated from each other by about 1.5 mm. Between the filament and the first plate is applied a voltage of about 100 volts. Hydrogen gas, introduced to the tube from a side chamber containing charcoal in which the gas is adsorbed, is ionized by the potential gradient between the filament and plate. A large supply of hydrogen ions (consisting of two or three ionized atoms each) is thereby made available. By applying a very high voltage (up to 30,000 volts) between the first and second plates, the ions pass through the accurately aligned perforations and emerge as beams of high speed ions. These beams, usually called canal rays, are directed toward the observation end of the tube. The ions, in returning to their normal atomic state, go through definite energy transitions, and in this process give off light of several different wavelengths. The wavelength of 4861 Angstrom units, a visible line in the hydrogen spectrum, was chosen as the basis of the study.

Outside the tube and adjacent to the observation window, an optical spectrograph was set up to analyze the light produced by the ions into its component spectrum colors. The spectrograph consists of a fine metal-on-glass grating, containing some 15,000 parallel ruled lines to the inch. The spectrum produced by this grating was focused on a photographic plate and recorded. The relative position of the spectrum lines on the plate indicates their relative wavelength, and any displacement of the lines toward the red end of the spectrum shows a decrease in the frequency of the light.

The experiment was difficult principally for the reason that the change in wavelength looked for was extremely small. The ions were accelerated by the high voltage to a speed about 0.005 the speed of light, and at this comparatively low speed, the change in wavelength is less than 0.05 Angstrom unit, necessitating a measuring accuracy of about 0.01 Angstrom unit. This is very high accuracy, even for spectroscopic work. It represents measurements

of length of about a ten thousandth of a millionth of a centimeter.

To make comparisons of the wavelengths produced by high speed particles with those of stationary ones, it has been suggested that the effect be measured by noting the wavelengths of the light from ions moving laterally past the spectrograph as compared with that from the stationary ions always present in the tube. This is a very difficult, if not impossible, experimental procedure, and has been avoided in Dr. Ives' equipment by the use of a mirror, which reflects light to the spectrograph, the light being produced by ions which are apparently moving away from the spectrograph. The mirror used is within, and slightly off the main axis of the tube. The apparatus is thus capable of measuring wavelengths produced by ions moving about 1000 miles a second toward the spectrograph, and at the same time by the use of the mirror, of ions moving at the same speed away from the spectrograph. The average wavelength of the two measurements would correspond to the wavelength produced by an ion at rest if no change in frequency was produced by motion. If a change does occur,

the average wavelength will differ from that due to the stationary ions.

The first experiments were tried with fast photographic plates, the exposure time being about one hour. During these tests, the entire apparatus (which is mounted on a massive rotatable steel platform) was rotated so that direction of the beam was successively to the east, north, west, and south. These results showed that the orientation of the instrument had no effect on the wavelengths, as was to be expected from theory. The final measurements were then made with much slower photographic plates, capable of revealing the position of the spectrum lines with much greater accuracy but requiring exposures of some 10 to 12 hours. Voltages of from 6800 to 18,400 were applied to the anodes, and kept constant to an accuracy of one-tenth of one per cent by an electrostatic voltmeter and an optical-beam indicating system. The voltage used is proportional to the square of the velocity attained by the ions, so the velocity attained can be computed, and the amount of wavelength shift to be expected therefrom can be compared with the shift actually observed. The agree-

ment is remarkably close. Close enough in fact to give a positive support of the shift predicted by Lorentz and Lamor, which in turn is based on the Fitzgerald contraction of distance- and time-measuring equipment.

The conclusion is that the long-suspected conspiracy of nature against detection of ether drift is indeed a fact. Thus Michelson and Morley, in finding no ether drift, did not disprove the existence of the ether. Rather they proved the existence of the conspiracy. The question of the ether is still an open one. On the one hand the phenomena of interference, so evident in directional antenna design, seem to demand a wave motion as the basis of radiant energy propagation, and a wave motion demands a medium. This is strong evidence in favor of an ether. On the other hand, the medium must behave very differently from any ordinary elastic medium, to satisfy the simultaneous requirements of density and elasticity required to achieve the observed speed of propagation. The odds at the present betting, seem about 11-to-9 in favor of the ether. For a real proof of its existence, the world still waits.

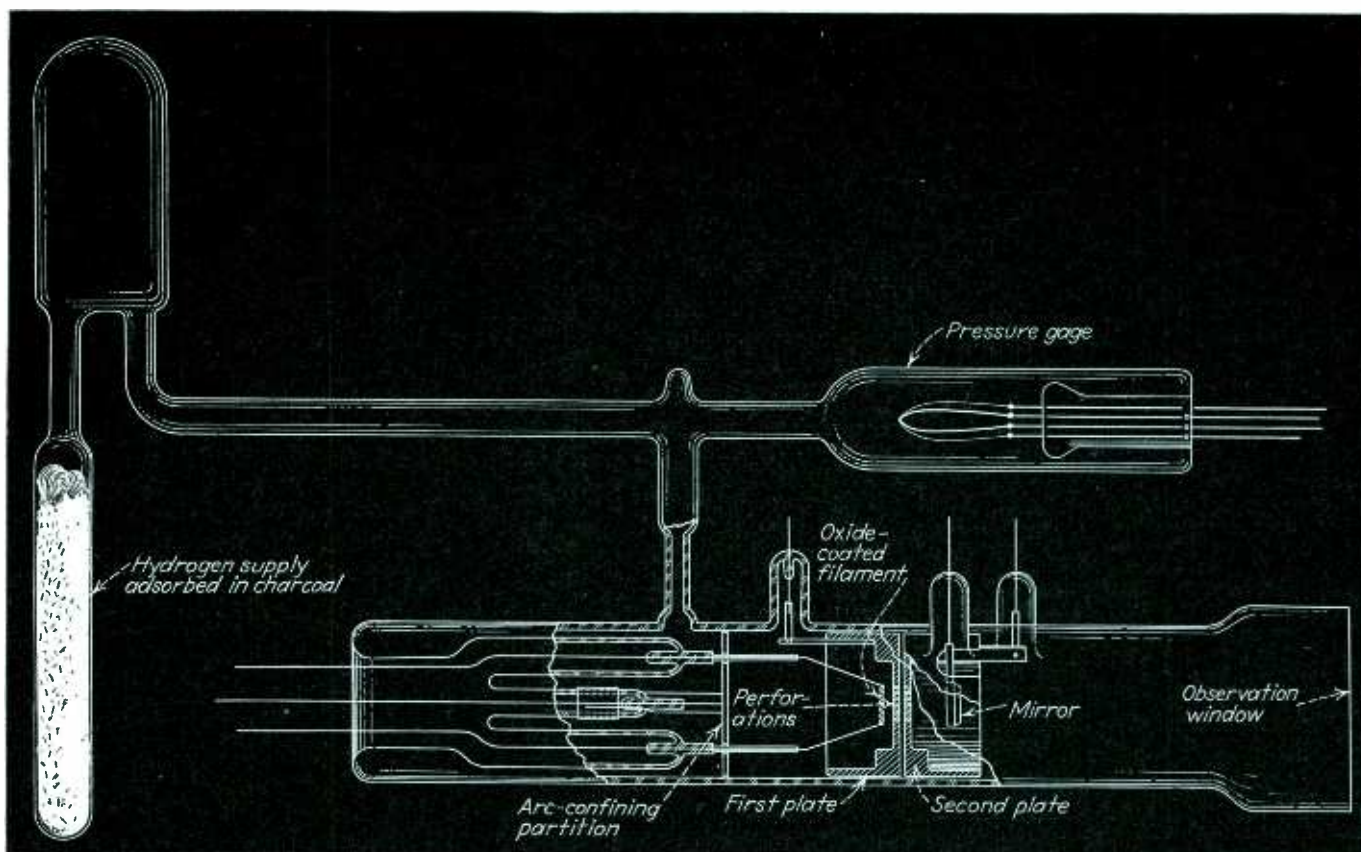

Schematic diagram of the positive-ion ray tube

What's New in Radio

A review of components and accessories recently announced by manufacturers in the ever-changing radio industry

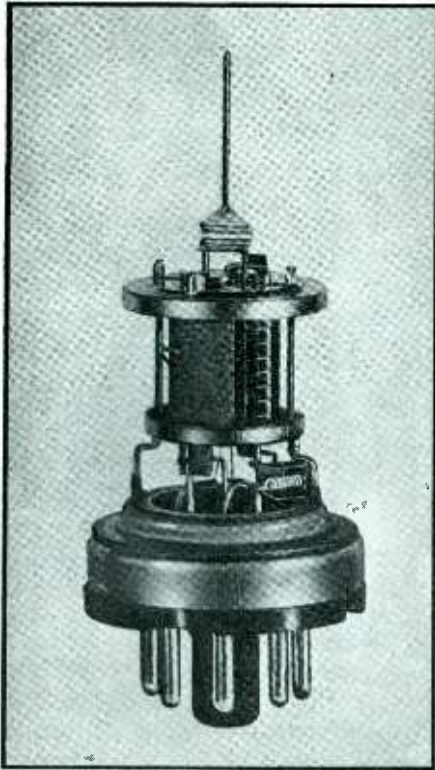

Elements of the RCA 1851 pentode, an experimental television tube having a gm of 9000

DESPITE the stagnation so evident in other branches of industry, the radio industry continues to pour forth new products and materials, new ideas, new schemes to make older equipment obsolete. The following brief summary of a few of the recent developments must necessarily be incomplete and may be considered as a sort of preview of many other new items to be seen before the summer is over. At the Radio Parts Show in Chicago, and at the IRE convention in New York, suppliers are planning to display interesting new products to prove again that the lifeblood of the industry resides in the products of its laboratories.

Measuring Equipment

No industry depends so much upon adequate measuring equipment as the manufacture and service of radio receivers. The continued offerings of the manufacturers to the radio service man are amazing. Entire new systems of servicing radio receivers are invented calling for new types of equipment. The cathode ray tube has come to be as much a part of the obscure technician's shop as it is necessary to the elaborate laboratory of the large manufacturer.

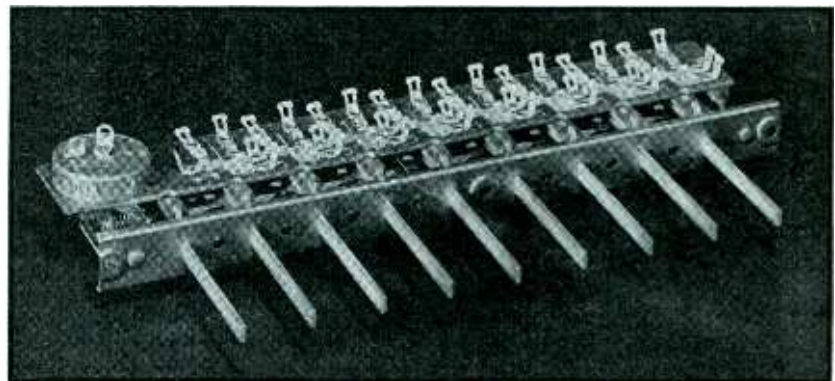
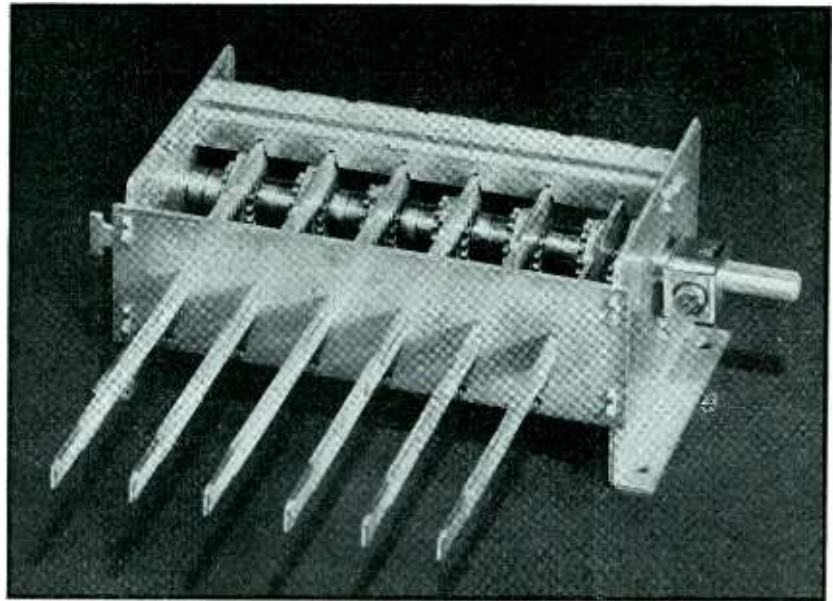

Two push-button assemblies manufactured by Oak. Above is a rack and pinion mechanical shaft-rotator, below, a highly flexible switch mechanism

Push-button tuning, introduced originally to enliven a lethargic radio set business, finds its way into service equipment in a new Triumph tube tester built after RMA standards. This device (Model 430) makes standard electronic conductance tests, checks shorts and open circuits in all types of tube. A system of push-button element-selectors makes quick tests possible. All anodes are paralleled for cathode emission tests which are quickly accomplished by pushing buttons designated on a roller index mounted in the center of the tester. The panel size is $7\frac{1}{2}$ by $9\frac{1}{4}$ in.

Another instrument designed to RMA standards, is available from Tobe Deutschmann. It places radio interference work on an engineering basis by allowing quantitative measurements to be made of noise intensities. The substitution method is employed. Two essentials of the instrument are a noise and fault locator and a calibrator. The purpose of the locator is to act as an uncalibrated vacuum tube voltmeter providing a visual indication of the magnitude of noise voltages, which are impressed on the input of the locator through a suitable network

of resistance and capacitance connected to the power circuit on which the noise is being distributed. The calibrator then provides a source of r-f voltage having standard waveform and modulation characteristics and permitting continuous control of frequency and amplitude so that the substitution of the calibrator output for the noise voltage at the input of

Brengle may be fitted into the support structure, thus making possible the mounting of service shop apparatus already possessed.

Communication Equipment

On a recent visit to Roosevelt Field, Mineola, N. Y., the editors of *Electronics* renewed acquaintance with Bill Lear, of Learradio. A new

plant finished in white (the employees wear white coats), air conditioned, and well lighted, provides excellent conditions for designing and manufacturing aircraft radio receiving and transmitting apparatus.

Among the equipment now in production is a six-frequency transmitter, a 20 to 30 watt unit weighing but 27 pounds, completely installed. The transmitter is tuned automatically, by a motor driven switch mechanism, to any of six preselected frequencies. Four beam-type tubes are used: The dynamotor power supply is mounted integral with the chassis base, and is supplied in two sizes. The normal installation delivers 20 to 30 watts, depending on the battery voltage and the antenna loading. A dynamotor with a somewhat higher voltage and power rating delivers from 25 to 40 watts, the increase in power being obtained without any other changes,

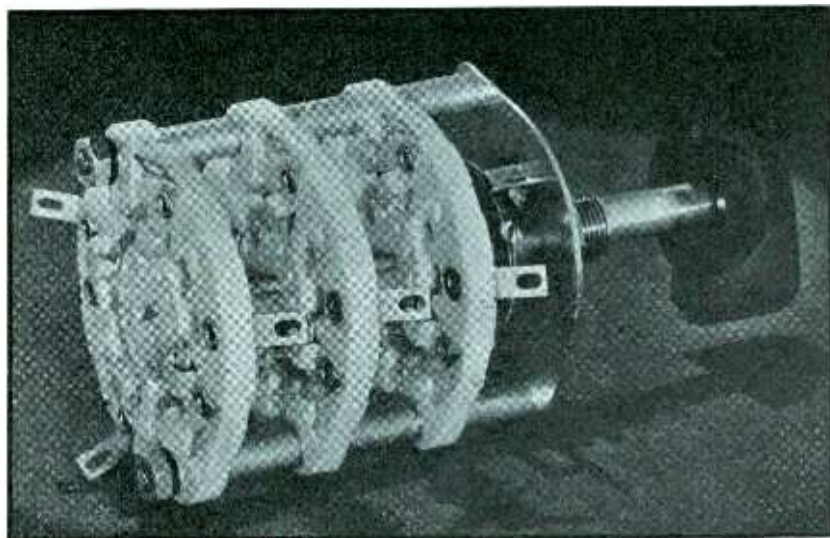

Centralab wave-change switch which allows up to 24 independent contact clips on the stator without back-to-back insulation

the locator allows the locator meter deflection resulting from the unknown voltage to be duplicated by means of the known voltage output of the calibrator.

This radio noise meter is a wholly self-contained, battery operated instrument conforming to the specifications established by the Joint Coordination Committee on Radio Reception of N.E.M.A., E.E.I., and R.M.A.

To aid the service man who cannot lay out the cash for a complete laboratory at one time, the Clough-Brengle Company has devised a unit assembly system which permits the owner to add instruments as he is able. The effect is to impress the customer with the fact that the service equipment to be used on the recalcitrant receiver is high class. Thus the public may better appreciate that radio servicing is a job requiring technical skill and equipment and disabuse itself of the present idea that all that is necessary is a screwdriver, a pair of pliers and a soldering iron.

Instruments other than Clough-

Right, mechanical push-button tuner of A. W. Franklin

Below, Audak's double inductor pick-up, described on page 19

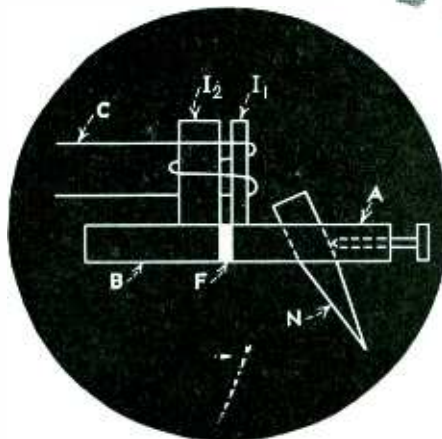
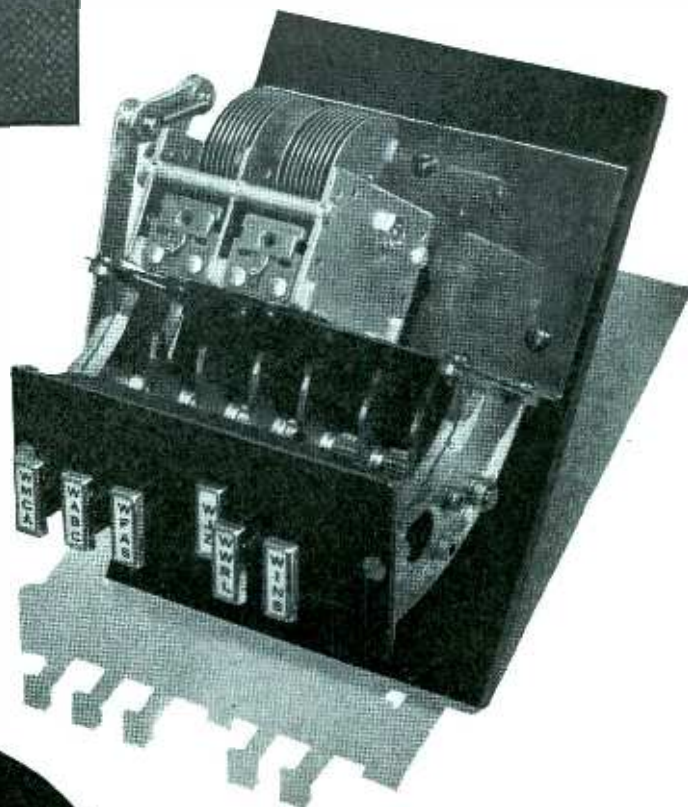

and involving only one-half pound extra weight.

A new Lear radio compass, model ARC-5, represents a new departure in that no remote control cables are used. The tuning circuits (r-f and mixing circuits for both loop antenna and vertical antenna) are contained in one small housing, on the panel of which are the antenna selector

switch, the band selector switch and the tuning dial. This unit is highly flexible: it will operate with loop antenna alone (for aural-null direction finding and anti-static reception), with vertical antenna alone (communication only), and with both loop and vertical antennas (visual indicator direction finding).

Another interesting piece of communication equipment is the Triumph radiophone control unit useful for lighthouse keepers, forest rangers, coast guardsmen or similar services where utmost simplicity of operation is desired. By this device it is possible for the lighthouse keeper, for example, to modulate his transmitter in 1020 cycle dots and dashes, to listen for reply on the same audio frequency while rejecting other audio frequencies, to stand-by for voice, or to talk by voice.

Midget Transformers

Production of new nickel iron alloys of high permeability has made possible reduction in size of audio frequency components. The most recent addition to the list of extremely compact transformers and chokes are the UTC Ouncer series. One of these transformers measures $\frac{7}{8}$ in. diameter by $1\frac{1}{2}$ in. long. It actually weighs 1.5 ounces, and has a good frequency characteristic. Ferranti and Amertran have small transformers also, and such midget devices are definitely indicated wherever space is at any premium at all. They can be purchased for use with d.c. in the primary (although the frequency characteristic is not so good in this condition) or for usage where the d.c. may be sent through another coil. Ferranti transformers are larger but will operate at higher levels, the Aero series working up to plus 22 db. The Ouncer series is limited to levels up to zero.

New Amateur Equipment

Both National and Hammarlund have brought out new forms of amateur transmitters. These are in "semi-kit" knock-down form, adapted to be put together most easily and quickly by the amateur. The amateur need no longer have a complicated mechanical workshop. Bud has brought out fixed air condensers for all-band amateur operation. They make it possible to maintain a proper

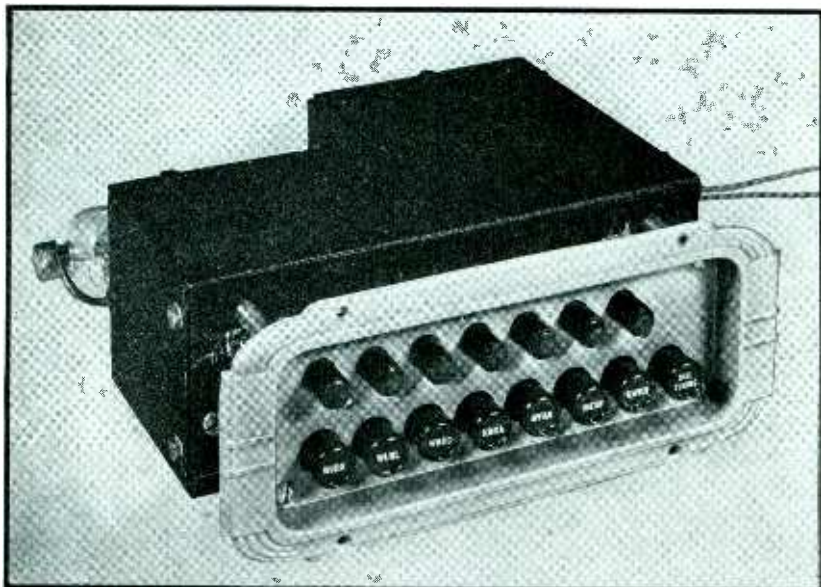
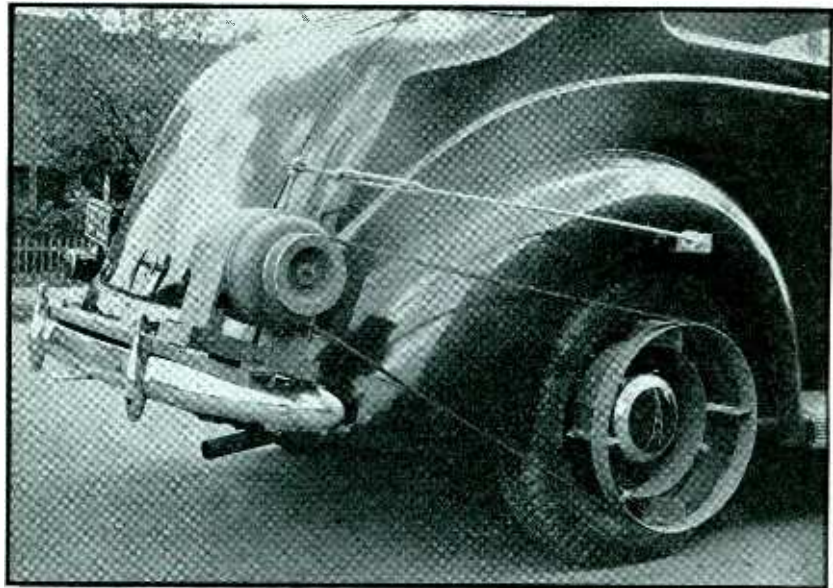

Above, Kato generator coupled directly to driving wheel. Can be used with car in motion or stationary by jacking up wheel. Below, Meissner modernization assembly, a permeability-tuned converter for attachment to any radio receiver

L/C ratio through a wide frequency spectrum. The insulation is Alsmag 196; the plates are brass and are solder welded to the shafts. Plates and rods are nickle plated. Incidentally, an old timer in radio, Raymond Francis Yates, appeared in *Electronics* editorial office recently with a successful method of plating cadmium on aluminum, making possible the use of this light metal in transmitter apparatus under conditions where aluminum itself would corrode.

Bud also has new neutralizing condensers with Isolantite insulation and split stator tuning condensers adapted for ultra high frequency circuits.

A radio interference filter capable

of preventing noise in high-power outdoor sign installations, is the product of J. W. Miller of Los Angeles. This is a 30-lb. choke wound with No. 1 B & S gauge cable, rated at 150 amperes with a 2-volt drop across the coil. Wave traps for eliminating interfering signals are an important part of the Miller line, which incidentally, has long contained a kit of parts for a high fidelity receiver first described in *Electronics* by W. N. Weeden (February 1937). This is a TRF circuit with an overall sensitivity of about 70 microvolts, and good frequency response out to 7,000 or 8,000 cycles.

Distinct advantages are becoming more evident for the use of flexible

shafting in the construction of home receivers. In these sets short lengths of shafting can be employed to connect volume and tone control to the corresponding knobs on the panel and for coupling parts of automatic tuning drives together. The use of these 2 to 6 in. shafts enables the designer to put the unit anywhere within reason and still to connect it properly with the panel knob.

Various types of shafting are available from S. S. White for this application; they differ in transverse flexibility, in diameter (from 0.130 in. to 0.188 in.) and in the end style. A square swaged and brazened end, for example, is recommended for use where fittings are swaged or soldered to the ends of the shaft. An octagonal swaged end is used when a set-screw adjustment is made.

Switches of various sorts have come to be a most important sector in radio set mechanical design. Centralab submits a "W" type of wave change switch which allows up to 24 independent contact clips on the stator without resorting to the usual expensive back-to-back clip insulating methods. By staggering rotor contacts 15 degrees, a 23 position selector switch can be furnished. A high frequency band change switch is also newly designed by Centralab.

New Pick-up

One of the neatest tricks of the year, it seems to this writer, is the new Audak pick-up. Maximilian Weil

states that his new creation reminds him of the story about the university professor who proved that no steamer could cross the Atlantic under its own steam because the fuel it would have to carry would take up more space than the size of the ship itself. Not long ago writers stated that the magnetic pickup had reached its acme of performance from the frequency characteristic standpoint because the heavy moving mass would limit its response at the higher frequencies. Yet the frequency range

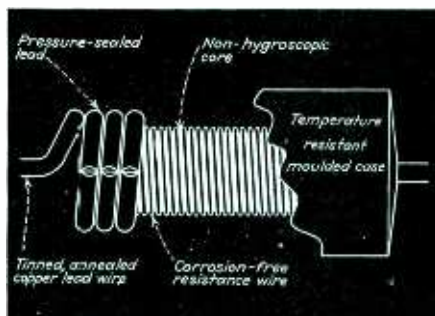

New wire-wound resistor construction employed by Speer Carbon

continually widens until a flat response from 30 to 10,000 cycles is attained in magnetic types. The trouble, according to Mr. Weil, is the fact that in recording there is a gradual loss in output at the lower frequencies to avoid over-cutting from one groove to another on low notes of high intensity.

This loss in low frequency response has been compensated by circuit networks in many cases. In the

new Audak pick-up another method of attack has been employed, a more elegant one, it seems. The operating principle of the unit will be understood from the figure. The shaft *A* carries a tiny inductor element *I*₁, which has secured to it the needle *N*. A second shaft *B* carries a larger inductor *I*₂ and is coupled to the shaft *A* through a special mechano low-pass filter *F*. The inductors are surrounded by the coil *C*. In operation, the inductor *I*₁, vibrates continuously with the needle and it alone, has a substantially flat response from 40 to well above 8,000 cycles. However, the filter *F* (made of a semi-crystallized substance), has characteristics such that vibrations above about 500 cycles are effectively prevented from reaching the shaft *B*. Below 500 cycles, this filter permits the vibrations to agitate the shaft *B*—such agitation gradually increasing as the frequencies become lower. The inductor *I*₂ is so proportioned, as to deliver a much higher output than the inductor *I*₁. The result is a gradually rising curve in the lower frequencies.

Measurements indicate that this new type of combined inductor-capacitor pick-up will have a rise in output of some 12.5 db at 46 cycles compared to the output at 1,000 cycles. The same unit is 2 db above the 1,000-cycle level at 8,000 cycles.

In electrolytic condensers there is always something new. Magnavox with Molanode condensers, Micamold with Tubalitics, Aerovox, Solar, Mallory all have brought out new condensers. Magnavox has made considerable progress with the idea of standardizing mechanical and electrical characteristics so that savings to the customer may be made. The anode is of new construction made of finely divided, fabricated aluminum material.

Compact etched plate tubular condensers available in dual, triple, and even quadruple types are available from Micamold. "X" model etched plate electrolytics are designed especially for service where current through them consists of a-c. Another new Micamold product is the Ballastron, cleverly designed plug-in ballast resistor. Resembling metal tubes in appearance these units have bases which enable them to utilize the modern octal construction.

(Continued on page 74)

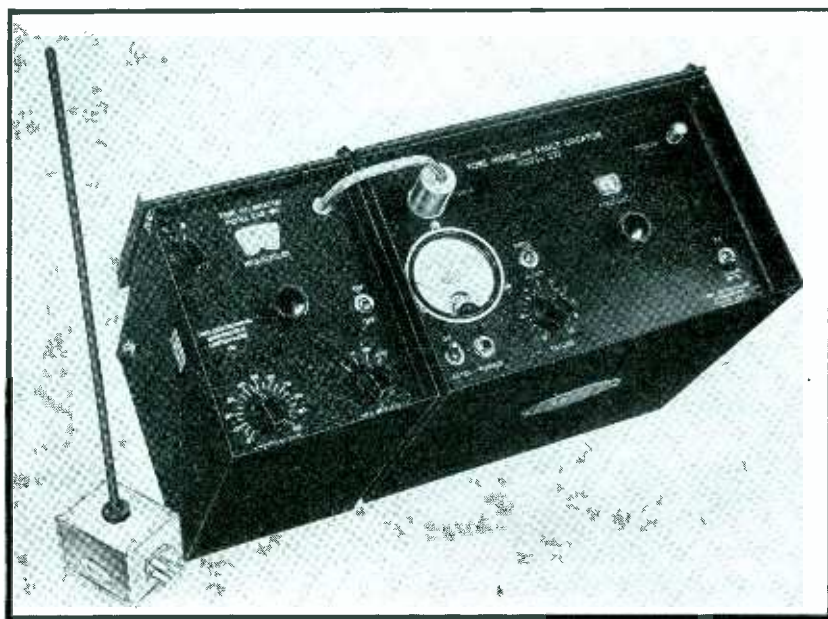

Tobe Deutschmann's noise and fault locator, designed to R.M.A. Standards

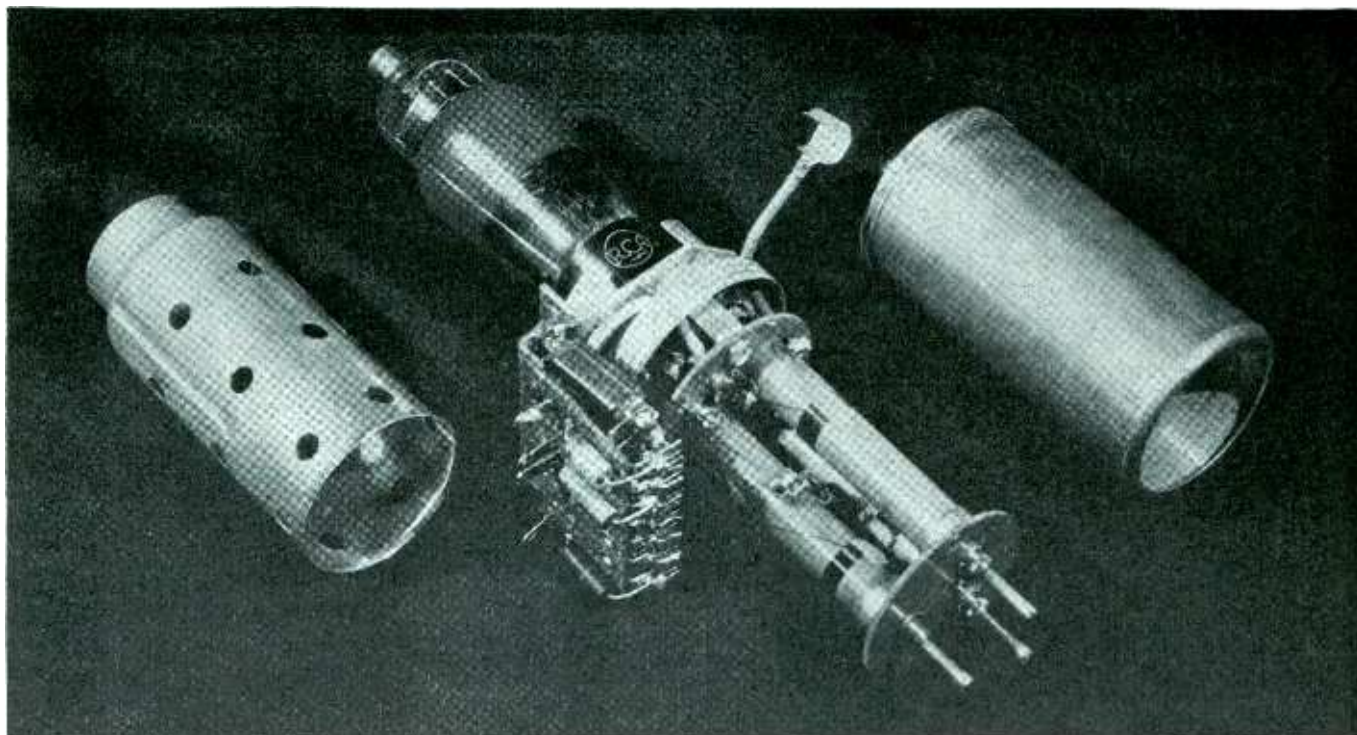

Fig. 1—Arrangement of tube and coupling i-f transformer in experimental receiver

By E. W. ENGSTROM and
R. S. HOLMES
RCA Manufacturing Co., Inc.
Camden, N. J.

Television I-F

PROBABLY the first consideration in i-f amplifier design is the choice of proper intermediate frequencies. There are a number of determining factors.

It is desirable that there be only one tuning control for picture and for sound. Therefore, the two intermediate frequency pass bands must accommodate signals separated by the same separation as the signals radiated from the transmitter. Much work has been done with the present tentative spacing of approximately 3,250 kc. This analysis will be based on a channel arrangement and carrier separation of 3,250 kc. as shown in Fig. 2. For each channel, the sound carrier is the higher in frequency. With the heterodyne oscillator in the receiver at a higher frequency than the received signals, the sound i-f produced will be lower in frequency than the picture i-f.

The sound i-f must be sufficiently high to permit good design for receiving signals at frequencies in the range of 44 to 108 Mc. The picture i-f will be higher by 3,250 kc. This, then, determines the lower limit of

possible intermediate frequencies. For the upper limit, regeneration and practicable circuit inductance are determining factors. The higher the i-f chosen, the more favorable will be the image frequency response ratio of the receiver. However, with too high an i-f, it will be difficult to obtain sufficient selectivity for the sound signals. The type of circuit to be used in the i-f transformers must also be considered. If inductive coupling is to be used, the coils must be large enough in dimensions so that sufficient coupling can be had in the picture i-f transformers without too close spacing and consequent critical characteristics.

A consideration of these factors indicate the range of 7 to 15 mc. for the intermediate frequencies. Having narrowed the choice to within these limits, there is another factor that should now be considered. This is to reduce the possibility of signals at intermediate frequencies, picked up by the antenna, reaching the i-f amplifier. Therefore, the intermediate frequencies should be chosen such that there is minimum likelihood of

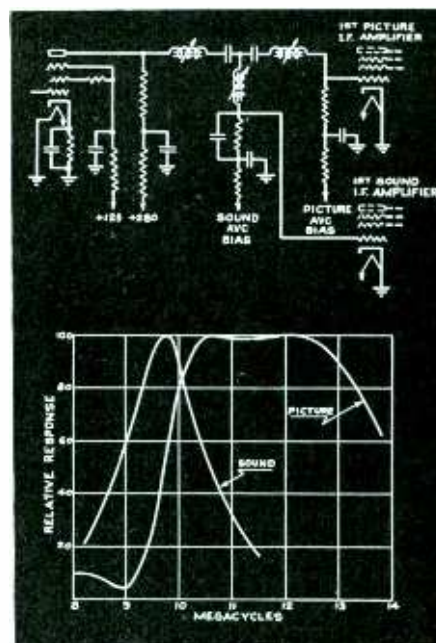

Fig. 3—Diagram and selectivity of first detector

strong signals in this same frequency range at the receiver locations. It is probable that receivers will more likely be near amateur transmitters than near other transmitters for this

In April 1938 the authors reviewed general problems in television receiver design and began an analysis of circuits. The antenna, r-f selector, oscillator and input portions of the first detector were covered. This article deals with i-f amplifiers for picture and sound.



Fig. 2—Television channel make-up

frequency range. There is an amateur band at about 7 Mc. and another at about 14 Mc. Thus it is desirable that the i-f amplifiers do not pass these bands. With this in mind, a picture intermediate frequency of 13 Mc. might be chosen with 9.75 Mc. for sound.

The pass band of the picture i-f

This arrangement entails added capacitance and loading—of the second tube—on the r-f circuit and therefore a decrease in performance. In some experimental receivers it has been found more desirable to use one first detector tube and to provide circuits in its plate circuit for supplying the resulting i-f signals to the two i-f amplifiers, one for picture and one for sound. The coupling transformer may be designed in a number of ways.

One design is to have one primary and two secondaries. In this case the picture secondary is tightly coupled to the primary and loaded with re-

nant to the sound i-f and the sound i-f signal is obtained across the capacitor of this series circuit. Both primary and secondary are loaded by shunt resistors. There is an R-C filter in each voltage supply lead to prevent reaction in other circuits.

Magnetite core tuning is very desirable for reasons of stability and ease of adjustment. It is also possible in some receivers to eliminate trimmer capacitors and thereby have a high L/C ratio resulting in high circuit impedance and gain for a given bandwidth.

The mechanical arrangement is such that the plate circuit is completely shielded. Transformers of this type may be mounted in a staggered arrangement so as to have short grid leads. This is important in re-

Amplifiers

amplifier then extends from 13 Mc. to approximately 10.5 Mc. accepting the carrier and the lower picture i-f sideband (corresponding to carrier and upper side band of the received signal). This amplifier should provide as much selectivity as possible beyond these limits, and in particular should have sufficient attenuation at 9.75 Mc. to eliminate the sound i-f carrier frequency.

The bandwidth requirement for the sound i-f amplifier is determined by circuit stability, oscillator frequency drift and ease of tuning the receiver. Since there is no selectivity requirement that is not easily met, a pass band in the order of 100 kilocycles is satisfactory.

First Detector Circuit

The first article reviewed the input portions of the detector circuit; we shall now consider the output portions. Two separate detector tubes might be used, one for picture and one for sound. The grids might be connected in parallel and the plates feeding separate i-f transformers.

distance so as to have a broad pass band. The sound secondary is more loosely coupled to the primary and is not loaded, thus having a relatively sharp pass band. This type of transformer has satisfactory performance but has disadvantages in practical arrangement. For example, if inductance tuning is used, as with an adjustable magnetite plug, the primary and secondary tuning will have interaction. Also the coils will have to be large in diameter in order to obtain sufficient coupling, so that they take up more space than they should.

These disadvantages are overcome by the circuit shown in Fig. 3. The primary and secondary have practically no magnetic coupling, but rather are coupled by an impedance which is common to both circuits. In some experimental receivers this (and all the other) i-f transformers the coil forms are small and there are no critical mechanical spacings. The coupling circuit is series reso-

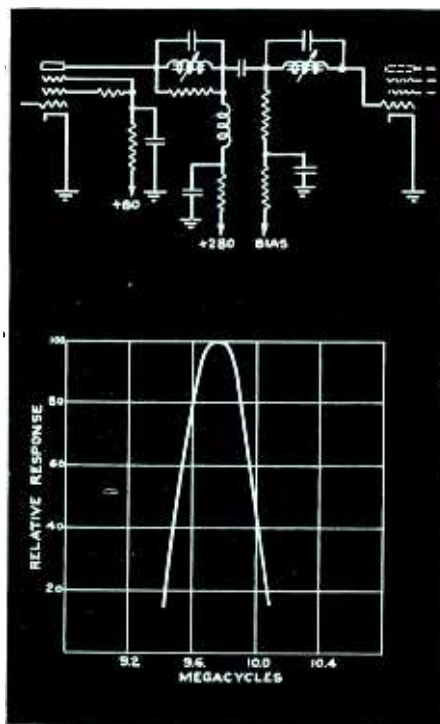

Fig. 4—Schematic diagram and selectivity of sound i-f stage

ducing capacitive coupling to other parts of the receiver.

Sound I-F Amplifier

The selectivity problems of the sound i-f amplifier are principally a function of circuit stability and ease of tuning the receiver. The pass band

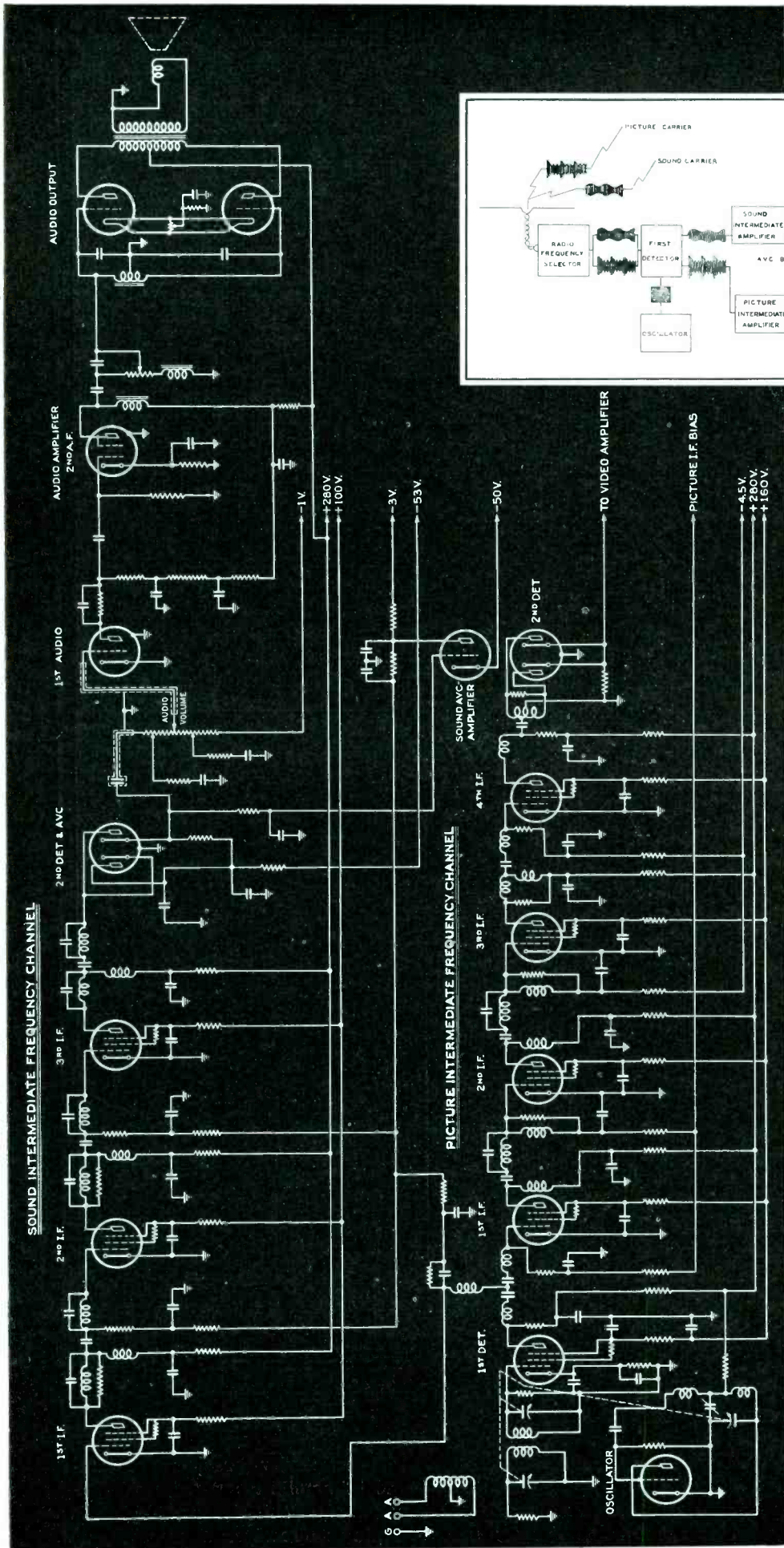
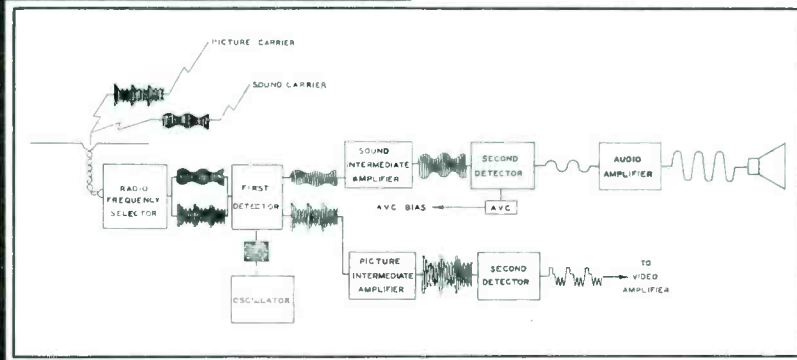

Fig. 9—Portions of television receiver covered in *Electronics* articles to date



must be sharp enough so that there is a very definite tuning point but broad enough so that normal oscillator frequency drift will not cause serious detuning. Also, the pass band should be broad enough so that receiver tuning is not too critical.

A pass band in the order of 100 kc. satisfies these conditions for sound reception in a television channel. With an amplifying system of these band pass characteristics there is obviously no side band trimming up to the second detector. The overall fidelity of sound reproduction is therefore a function of the audio frequency amplifier and the loudspeaker.

The i-f transformers for sound may be of any suitable type. One satisfactory form of transformer is shown in Fig. 4. Both primary and secondary are tuned by means of magnetite plugs and coupling is by the common impedance in the plate supply lead of the amplifier tube. Coupling is varied by varying the value of the coupling inductance. This type of transformer is easy to adjust because primary and secondary tuning are practically independent of each other and such tuning does not affect the coupling.

Three stages of this type of i-f amplification should provide sufficient sensitivity to reach the "noise level". Amplification is naturally dependent upon the characteristics of the amplifier tube. Desired characteristics include high transconductance and a remote grid cut-off of exponential character. Overall selectivity of a sound i-f amplifier incorporating the detector circuit of Fig. 3 and three stages of i-f amplifiers of Fig. 4 is as shown in Fig. 5.

The second detector for sound may be a conventional diode. However,

since the i-f transformers have relatively low impedance, increased gain may be obtained by using a voltage doubler arrangement for the sound second detector. This is an advantage also in the AVC circuit, because the d-c as well as the a-c voltage is increased with this circuit. This is shown on the schematic diagram Fig. 9. Some form of automatic volume control is essential. An AVC of the "amplified" type may be chosen because of its very flat characteristic. This may be a d-c amplifier between the second detector diode and the grid returns of the i-f amplifier tubes. The second detector should be followed by a wide band a-f amplifier of low distortion, and a suitable loudspeaker.

Picture I-F Amplifier

The amplification and selectivity

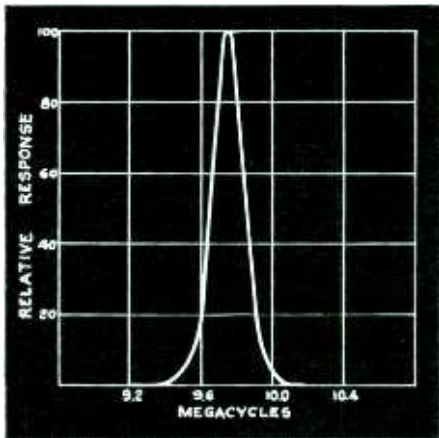

Fig. 5—Overall selectivity of sound intermediate amplifier

problems for picture are more complex than for sound. The picture intermediate frequency of 13 Mc. with one side band must be passed and sufficient attenuation must be provided at the sound intermediate frequency of 9.75 Mc.

An i-f transformer circuit of satisfactory type is shown in Fig. 6. Here the primary and secondary are both tuned with magnetite plugs and the secondary is loaded with resistance. Coupling is by a tuned circuit connecting the high signal potential ends. This tuned circuit in the coupling element is adjusted to resonate at the sound i-f so that it acts as a trap or rejector for this frequency. The response characteristic of this i-f stage is also shown in Fig. 6. It is to be noted that the response

falls off faster as the sound intermediate frequency is approached than for the series circuit in the transformer in the plate circuit of the first detector (see Fig. 3).

To provide sufficient rejection at the sound i-f, at least two stages similar to Fig. 6 are required. Additional i-f stages needed to produce

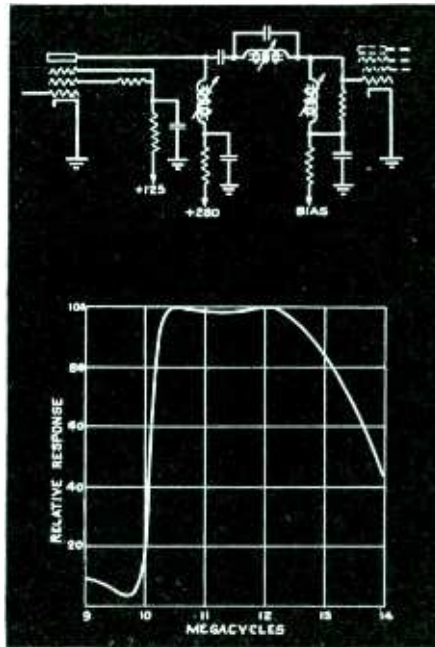

Fig. 6—Circuit and selectivity of picture i-f stage with rejector

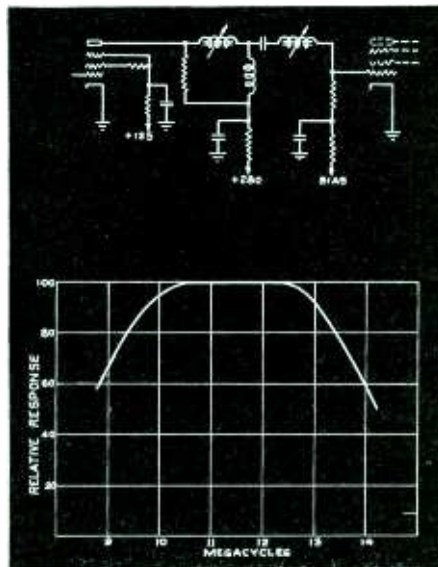

Fig. 7—Circuit and selectivity of picture i-f stage without rejector

the sensitivity desired may be of the type shown in Fig. 7. The response characteristic is also indicated.

The overall selectivity of a picture i-f amplifier consisting of a first detector stage (Fig. 3), two i-f stages with rejectors (Fig. 6), and two i-f

stages without rejectors (Fig. 7), is shown in Fig. 8. The amplifier tube characteristics are of extreme importance for the wide band pass needed for picture. High transconductance is imperative for reasonable gain at desired frequency response characteristics. Another desirable factor is remote grid cut-off of exponential form. The i-f stages described in this article used tubes of moderate transconductance. The transconductance of the tubes used was increased somewhat by tying the suppressor to the screen in all the i-f amplifier stages so that the effective transconductance was in the order of 2,000 to 3,000 micromhos.

Referring to Fig. 8, it is to be noted that the response is falling at the picture intermediate frequency. To produce a uniform fidelity characteristic, the overall selectivity

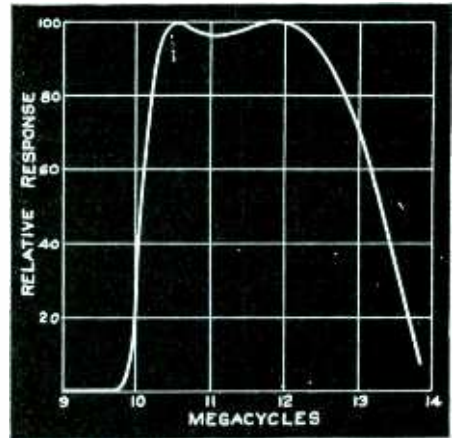

Fig. 8—Overall selectivity of picture i-f amplifier

(combined r-f and i-f selectivity) should be such that the picture "carrier" falls at the point where the response is 50% of maximum. This provides optimum phase and amplitude characteristics when using only one of the picture side bands.

Referring also to Fig. 8, the ratio of gain at the picture i-f to that at the sound i-f is considerable (over 100 to 1). This discrimination, plus additional rejection in the video frequency amplifier at the difference frequency between picture and sound carriers, is ample to eliminate effects of "sound" in the picture for normal operating conditions.

The third article of this series will cover automatic volume control problems for picture and the video frequency amplifier.

ELECTRONIC SALES AIDS

Dramatic application of tube circuits and equipment permitting potential customers to demonstrate to themselves how electrical appliances, or musical instruments, work. Methods could be applied to other types of demonstration apparatus

By BERNARD EPHRAIM

DYNAMIC application of electronic devices to promotional advertising is a field in which there are practically no competitors. Promotional advertising is eagerly sought by all manufacturers and radio-electrical appliance distributors. Department and chain store outlets are continually entertaining new ideas in which to merchandise their wares; and few are turned away who can demonstrate the practicability of a new type of unusual promotion.

There is an almost inexhaustible supply of electronic apparatus commercially available, and little has been done with it in an advertising sense excepting the attempts made to apply the photocell and capacity switch.

An excellent application of electronic equipment is the use of a short wave telephone dial-operated transmitter, which by simply dialing any one of the numbers can cause any appliance, such as a radio, washing machine, ironer, etc., to go into action for a predetermined length of time. A display incorporating this type of control was built and leased by the writer to West Coast appliance distributors. The accompanying photo shows the "magic dial" demonstrating General Electric household appliances. The small black bakelite box has no wires nor connections running to or away from it, there are no switches to operate, no pushbuttons to press—nothing to do but to pick up the little box and walk about the exhibit dialing as fancy directs for an appliance demonstration.

The transmitter, pictured with the dial in Fig. 4 is contained in a

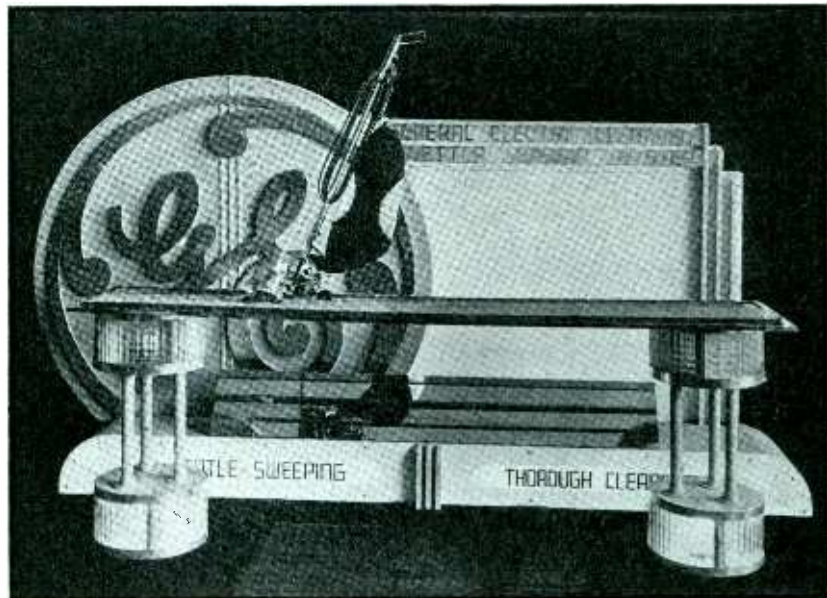

Fig. 1—By stating into a microphone "me for a G.E." passersby set into motion the suction sweeper via a low-powered oscillator with absorption modulation

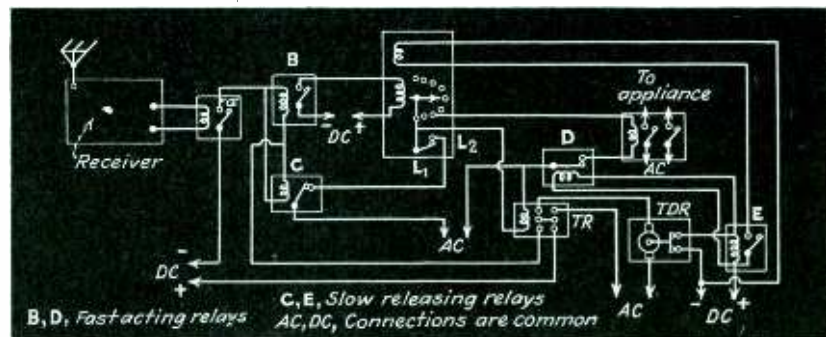

Fig. 2—Circuit showing switching system of the dial type of demonstration set-up

small bakelite box having dimensions of 6x6x3 in. and weighing only four pounds complete. The transmitter is fixed tuned and contains only one type 30 tube used as a combination 6-meter oscillator and 1000-cycle modulator, the energy being radiated directly from the tank circuit without aerial or ground connections. The signal strength is sufficient to drive a super-regenerative receiver to full output at a distance

of more than 500 feet. Two small one and one-half volt flashlight cells furnish the filament current which is delivered only when the dial is being operated. This is accomplished by modifying the contact springs on the dial impulse mechanism. The plate voltage is applied only on the return motion of the dial from the finger stop, the number of interruptions governs the number of r-f impulses transmitted. The dial acts both as



Fig. 3—Outdoor application of the dial-type of sales aid in which dialing selects phonograph recording of the desired instrument

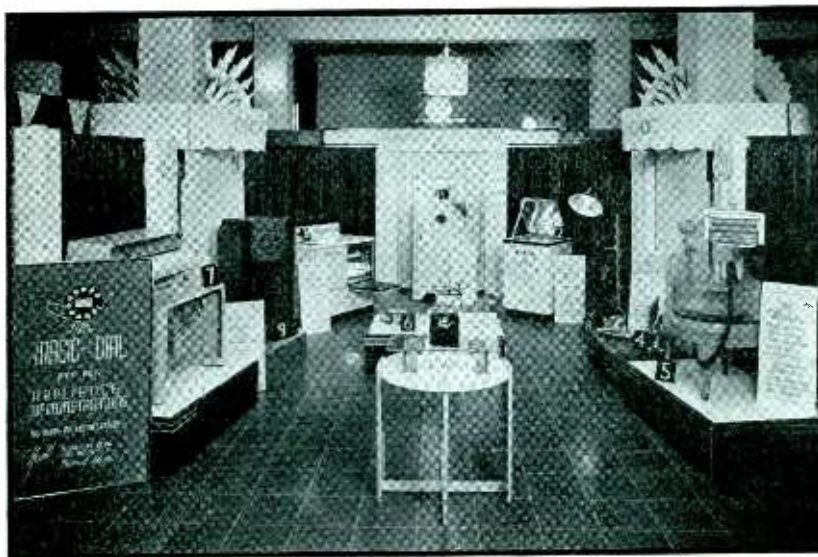

Fig. 4—Using a high-frequency transmitter and a super-regenerator receiver, various appliances in this exhibit may be "dialed" into operation

filament switch, plate voltage control and transmission governor. The flashlight batteries have a life of about 30 days and the transmitter can be operated continuously for 10 hours daily without any noticeable decrease in output signal strength.

The receiver is of the super-regenerative type containing only a detector, an interruption oscillator, a tube-operated sensitivity control and two stages of direct coupled voltage am-

plifiers, the output directly energizing an impulse control relay. The sensitivity control governs the permissible amount of excitation impressed upon the detector. The proper excitation must be greater than one-half the time duration of the input signal so as to allow the receiver to discriminate between static transients and signal impulses. The receiver is manually tuned to the transmitter. A short 6-foot an-

tenna is all that is required, no ground being necessary.

The operation of the circuit selection system can be followed from the condensed diagram of Fig. 2. Each time contacts 'a' close, relay B (fast pull-up and drop-out) and C (fast pull-up and slow drop-out) are energized. Relay B closes the circuit to the impulse coil on the rotary selector switch. The rotary arm on this switch normally rests on an open circuit, off control contacts 1 to 9. In this position auxiliary contact springs L_1 and L_2 are normally held open, the contacts are provided to isolate the a-c power from the rotary arm before it begins its motion. As long as the 'a' contacts open and close, relay C will remain open (back contacts open) and the rotary arm will accordingly traverse its contact quadrant stepping-up one position for each impulse. When no more impulses are received, relay C will be de-energized and close the circuit through the rotary switch arm which in turn closes the 110-volt a-c power relay in the circuit selected. A transfer relay TR is placed in the rotary switch arm circuit to open the B and C relay connections and to close the time delay motor circuit. Opening B and C prevents the selection system from being operated until the time delay relay TDR closes and energizes the restoring coil on the selector switch to cause the rotary contact arm to return to its normal off-contact position. Relay D takes the a-c power off the controlled circuit and rotary arm during the time the rotary contact is returning to its home position.

An outdoor adaptation of the above selection equipment, used by the largest chain of retail music stores in the West, is shown in Fig. 3. Here the dial is mounted directly to the store window by means of vacuum stickers vulcanized to the glass with cold rubber cement. The selection equipment electrically selects sales and music recordings from an automatic phonograph.

The window type of dialing device contains a small resonating coil and variable condenser. The coil is mounted flat to the outside of the window by supports inside the steel housing. The impulse contacts on the dial mechanism open the parallel resonant circuit connections for each

(Continued on page 77)

INSTITUTE OF RADIO ENGINEERS

THIRTEENTH ANNUAL CONVENTION

HOTEL PENNSYLVANIA . . . NEW YORK . . . JUNE 16, 17, 18, 1938

PROGRAM

WEDNESDAY, JUNE 15

4:00 P.M.—6:00 P.M.

Registration.

THURSDAY, JUNE 16

9:00 A.M.

Registration and opening of exhibition.

11:00 A.M.—12:30 P.M.—Ballroom

Official welcome by Haraden Pratt, President of the Institute.

"KDKA Low-Angle Antenna Array", by Ralph N. Harmon, Westinghouse Electric and Manufacturing Company, Chicopee Falls, Mass.

"A Short-Wave Single-Side-Band Radiotelephone System", by A. A. Oswald, Bell Telephone Laboratories, Inc., New York, N. Y.

"A Single-Side-Band Receiver for Short-Wave Telephone Service", by A. A. Roetken, Bell Telephone Laboratories, Inc., New York, N. Y.

"A New Antenna System for Noise Reduction", by V. D. Landon and J. Reid, RCA Manufacturing Company, Inc., Camden, N. J.

2:30 P.M.—4:30 P.M.—Ballroom

"A 50 Kilowatt Broadcast Station Utilizing the Doherty Amplifier and Designed for Expansion to 500 Kilowatts", by W. H. Doherty, Bell Telephone Laboratories, Inc., New York, N. Y., and O. W. Towner, The Louisville Times Company, Inc., Louisville, Ky.

"Recent Developments in Radio Transmitters", by J. B. Coleman, and V. E. Trouant, RCA Manufacturing Company, Inc., Camden, N. J.

"A High Efficiency Modulating System", by A. W. Vance, RCA Manufacturing Company, Inc., Camden, N. J.

"Technical Equipment of the New KYW Studios", by Arthur G. Goodnow, Westinghouse Electric and Manufacturing Company, Chicopee Falls, Mass.

"Design Requirements for Broadcast Studio Audio-Frequency Systems", by H. A. Chinn, Columbia Broadcasting System, Inc., New York, N. Y.

2:30 P.M.—4:30 P.M.—Parlor I

"Application of Quartz Crystals to a Wave Analyzer", by L. B. Arguimbau, General Radio Company, Cambridge, Mass. (Demonstration.)

"Bridged-T and Parallel-T Null Circuits for Measurements at Radio Frequencies", by W. N. Tuttle, General Radio Company, Cambridge, Mass.

"Some Applications of Negative Feedback with Particular Reference to Laboratory Equipment", by F. E. Terman, R. R. Buss, W. R. Hewlett and F. C. Cahill, Stanford University, Calif.

"The Bridge-Stabilized Oscillator", by L. A. Meacham, Bell Telephone Laboratories, Inc., New York, N. Y. (Demonstration.)

"Evacuated-type Crystal Oscillator Holder", by C. F. Baldwin, General Electric Company, Schenectady, N. Y.

7:30 P.M.—10:00 P.M.—Ballroom

Presentation of Institute Awards.

"Input Impedance of Converter Tubes", by J. R. Nelson, Raytheon Production Corporation, Newton, Mass.

"A Push-Pull Ultra-High-Frequency Beam Tetrode", by A. K. Wing, RCA Manufacturing Company, Inc., Harrison, N. J. (Demonstration.)

"Control of the Effective Internal Impedance of Amplifiers by Means of Feedback", by H. F. Mayer, General Electric Company, Schenectady, N. Y.

"Use of Feedback to Compensate for Vacuum-Tube Input-Capacitance Variations with Grid Bias", by R. L. Freeman, Hazeltine Service Corporation, New York, N. Y.

"Automatic Selectivity Control Responsive to Interference", by J. F. Farrington, formerly of Hazeltine Service Corporation, New York, N. Y.

FRIDAY, JUNE 17

9:00 A.M.

Exhibition opens.

10:30 A.M.—12:30 P.M.—Ballroom

"Development of an Ultra-High Frequency Transmitter for Aircraft Instrument Landing", by P. J. Kibler, Washington Institute of Technology, Washington, D. C.

"Air-Track System of Aircraft Instrument Landing", by G. L. Davies, F. G. Kear, and G. H. Wintermute, Washington Institute of Technology, Washington, D. C.

"Further Developments in the Design and Technique of Operation of Mobile Field-Intensity-Measuring Equipment", by W. A. Fitch, National Broadcasting Company, Inc., New York, N. Y.

"Lateral Disk Recording for Immediate Playback with Extended Frequency and Volume Range", by H. J. Hasbrouck, RCA Manufacturing Company, Inc., Camden, N. J. (Demonstration.)

"A New High-Fidelity Reproducer for Lateral Disk Records", by H. J. Hasbrouck, RCA Manufacturing Company, Inc., Camden, N. J. (Demonstration.)

10:30 A.M.—12:30 P.M.—Parlor I

"A Consideration of the Radio-Frequency Voltages Encountered by the Insulating Material of Broadcast Tower Antennas", by G. H. Brown, RCA Manufacturing Company, Inc., Camden, N. J. (Demonstration.)

"The Operating Characteristics of Radio-Frequency Transmission Lines as Used with Radio Broadcasting Antennas", by C. G. Dietsch, National Broadcasting Company, Inc., New York, N. Y.

"Design and Tests of Coaxial Transmission-Line Insulators", by W. S. Duttera, National Broadcasting Company, Inc., New York, N. Y.

"Coupled Transmission-Line Networks", by A. Alford, Mackay Radio and Telegraph Company, New York, N. Y.

"Communication by Phase Modulation", by M. G. Crosby, RCA Communications, Inc., Riverhead, L. I., N. Y.

"Oscillograph Design Considerations", by G. R. Mezger, Allen B. DuMont Laboratories, Passaic, N. J. (Demonstration.)

2:00 P.M.—4:00 P.M.—Ballroom

"Contrast in Kinescopes", by R. R. Law, RCA Manufacturing Company, Inc., Harrison, N. J.

"Recent Improvements in the Design and Characteristics of Iconoscopes", by R. B. Janes, and W. H. Hickok, RCA Manufacturing Company, Inc., Harrison, N. J.

"The Image Iconoscope", by H. Iams, G. A. Morton and V. K. Zworykin, RCA Manufacturing Company, Inc., Harrison, N. J.

"Electrostatic Electron Multiplier", by V. K. Zworykin, and J. A. Rajchman, RCA Manufacturing Company, Inc., Harrison, N. J.

8:30 P.M.—1:00 A.M.

Boat trip on the Hudson River.

[Continued on page 94]

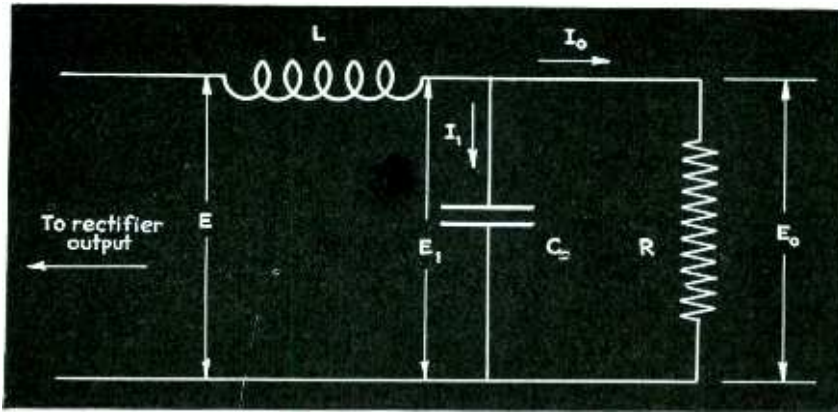

Fig. 2—Schematic diagram of the L section filter upon which the filter design is based

The ripple fraction r may be expressed as the ratio

$$r = E_1/E_o$$

and the per cent ripple is $r \times 100$.

Examination of Table I shows that the magnitude of the main ripple frequency voltage is very much greater than the magnitudes of the voltages of the second and third harmonics of this ripple frequency. This, together with the fact that the filter is much more effective in its filtering action at these higher harmonic frequencies, makes it possible to ignore all but the main ripple voltage in the determination of the ripple fraction r and the determination of the proper values for L and C .

Assuming that I_1 flows entirely through C ,

$$I_1 = \frac{E_{ac}}{\omega L - 1/\omega C}$$

and,

$$E_1 = I_1/\omega C$$

The ripple voltage across the load in terms of the ripple fraction and the d-c voltage is

$$E_1 = rE_o$$

and the a-c input voltage to the filter may be written as

$$E_{ac} = FE_o$$

where F is a factor obtained from Table I and expresses the ratio of the peak value of the a-c component of voltage (main ripple voltage) in the rectifier output to the d-c component of voltage in the rectifier output for the particular type of rectifier used. For a three phase half wave rectifier for instance, F is seen to be equal to 0.25. Upon elimination of I_1 from the above equations there results,

$$\frac{FE_o}{\omega L - 1/\omega C} = \omega r CE_o$$

from which,

$$LC = \frac{F-r}{\omega^2 r} = \frac{1}{\omega^2} \left(\frac{F}{r} - 1 \right) \quad (1)$$

This is the value that the product LC must have if the ripple appearing across the load is to be the value determined by r .

There is a further condition which must be imposed upon the filter and which arises from the fact that at no time during the normal operation of the rectifier must the current delivered to the load become discontinuous. For this condition to be met the peak value of the a-c current I_1 flowing through the inductance L must not exceed the d-c load current I_o which is also flowing through the inductance.¹ In the limiting case these

two values of current may be just equal to each other. Furthermore, this condition must be met for the minimum load current, I_{min} that the rectifier will be called upon to supply. The magnitude of I_1 remains essentially constant regardless of normal variations in load current so that if I_1 is maintained at a value equal to or less than I_{min} for the minimum load point it will automatically remain less than the d-c current for larger values of load. For the limiting case then,

$$I_1 = I_{min}$$

but

$$I_1 = \frac{FE_o - rE_o}{\omega L}$$

Let the ratio of full load current I_o to the minimum value of load current I_{min} be k then,

$$I_{min} = I_o/k$$

or,

$$I_{min} = \frac{E_o}{kR}$$

Equating the expressions for I_1 and I_{min}

$$\frac{FE_o - rE_o}{\omega L} = \frac{E_o}{kR}$$

which gives,¹

$$L = \frac{(F-r)kR}{\omega} \quad (2)$$

¹Terman, "Radio Engineering", Second edition, p. 488. McGraw-Hill Book Company.

Fig. 3—LC product for various types of rectifiers shown in Fig. 1, for specified ripple voltage in output

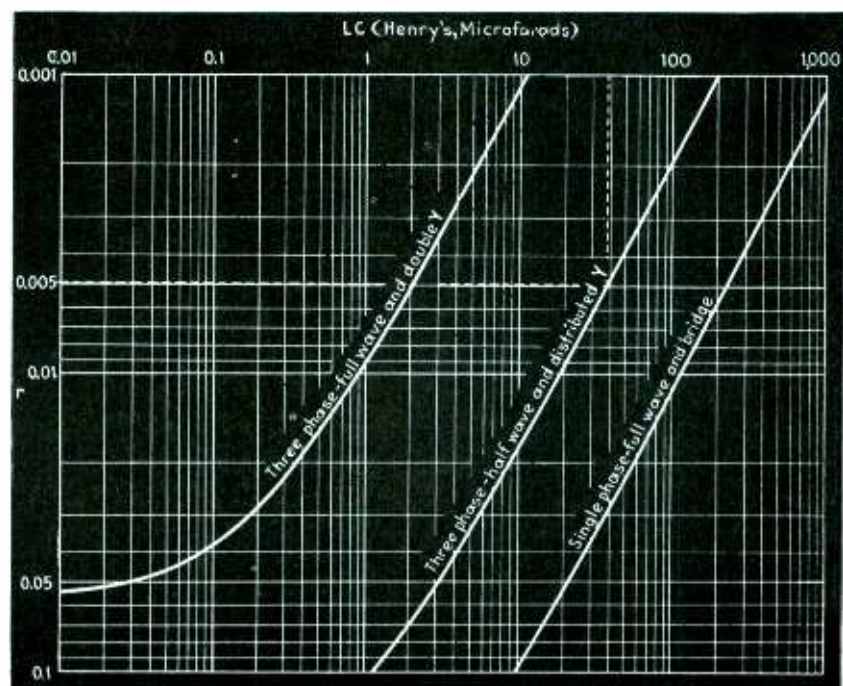

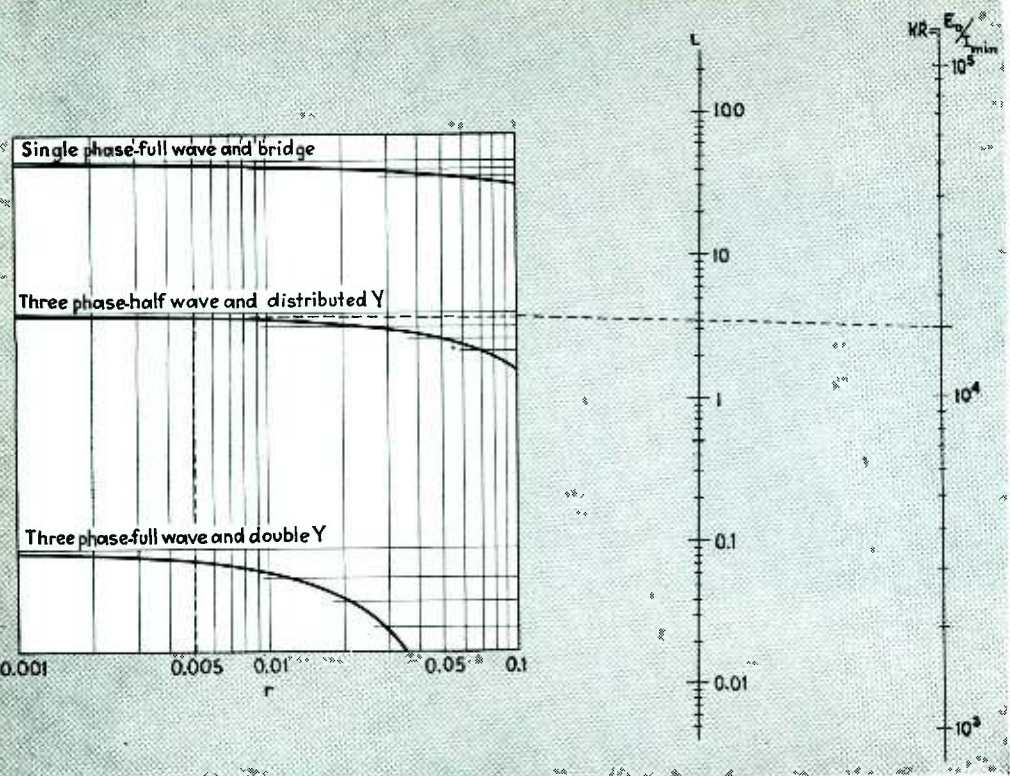

Fig. 4—Alignment chart for determining minimum inductance required for given ripple voltage

as the minimum value that L may have and meet the condition that I_1 shall not be greater than I_{min} .

If the value of the product LC is determined as in equation (1) in which the ripple voltage appearing across the load is limited to a certain fraction r of the d-c output voltage, the ratio of the two quantities LC/L gives the maximum value that C may have. It must be remembered that the values of L and C so obtained are limiting values only, that is,

$LC =$ a certain quantity as determined from (1)

$L \geq$ a certain quantity as determined from (2)

$C \leq$ a certain quantity as determined above.

In general this ratio LC/L results in an unsatisfactory size for C from a standpoint of economic choice. The final choice of L and C must depend upon economic considerations and the necessity of utilizing components in sizes available from the manufacturer. It makes no difference in the performance of the filter section if L is chosen n times as large as given

by (2) and the value of C is $\frac{1}{n}$ -th

as large as determined above so long as the product of these remains equal to the value of LC as determined from considerations of allowable ripple, and so long as the value of X_c remains small with respect to R . A further condition is sometimes im-

posed upon the value of C by stating that the filter condenser shall have an impedance not to exceed a certain amount at some specified minimum frequency.² Such a criterion then would establish a minimum value for C .

To facilitate computation two charts have been prepared, one giving the product of LC as a function of the ripple fraction r and the type of rectifier employed (Fig. 3), and the other giving the minimum value of L as a function of the ripple fraction r , the type of rectifier, and the value of $kR = E_o/I_{min}$. (These charts are based upon a frequency of 60 cycles

for the power supply system).

As an example of the application of the above discussion to a typical design problem consider a three phase half wave rectifier which is to supply a load with 4,000 volts d-c and a full load current of 1 ampere. The filter is to be designed so that the ripple appearing across the load is to be limited to 0.5%. What must be the values of L and C to give the desired performance?

Assume I_{min} to be one-fourth full load current, then $k = 4$ and $kR = E_o/I_{min} = 4000/0.25 = 16,000$. The chart of Fig. 3 shows that for a rectifier of this type and a ripple fraction $r = 0.005$, the product $LC = 38.4$. For $kR = 16,000$ and $r = 0.005$, the chart of Fig. 4 gives the minimum value of L as 3.5 henrys. The maximum value that C may have then is $LC/L = 38.4/3.5 = 11 \mu f$. The value of C thus obtained is larger than would be used in practice and represents simply a limiting value.

If the criterion previously mentioned is applied by stating that at 40 cycles the impedance represented by C shall not exceed 1000 ohms, a condenser of at least $4 \mu f$ must be used. This would necessitate an inductance of $L = 38.4/4 = 9.6$ henrys. A filter section then composed of an inductance of 9.6 henrys and a capacity of $4 \mu f$ would result in an entirely satisfactory filter which meets the requirements of minimum L , ripple of 0.5%, and X_c less than 1000 ohms at 40 cycles, and always very much less than R .

² Eastman, "Fundamentals of Vacuum Tubes", p. 66. McGraw-Hill Book Company.

Table I—Relative magnitudes of fundamental and harmonics for various types of rectifiers

| | Single phase full wave | Single phase full wave bridge | Three phase half wave | Three phase distributed Y | Three phase double Y | Three phase full wave |
|---|------------------------|-------------------------------|-----------------------|---------------------------|----------------------|-----------------------|
| Fundamental ripple frequency f_r (frequency of power supply = 60 cycles)..... | 120 | 120 | 180 | 180 | 360 | 360 |
| Peak value of fundamental ripple voltage in rectifier output, * F_r | 0.667 | 0.667 | 0.25 | 0.25 | 0.057 | 0.057 |
| Peak value of second harmonic ripple voltage in rectifier output.* | 0.133 | 0.133 | 0.057 | 0.057 | 0.014 | 0.014 |
| Peak value of third harmonic ripple voltage in rectifier output.*..... | 0.057 | 0.057 | 0.025 | 0.025 | 0.006 | 0.006 |

*The direct-current component of voltage in the rectifier output is considered as unity.

the plate transformer supplies no more power than the maximum plate dissipation, it should be of liberal size and have a low ohmic resistance so that the high peak value of plate current does not cause an excessive drop in potential at the secondary terminals of the transformer. The transformer potential is continuously variable by means of a liberal-sized variac or autotransformer with variable tap on the output side.

The grid circuit includes similar elements such as the wattmeter P_g for indicating grid dissipation, the grid transformer, and the grid resistance R_c . In addition, the grid circuit contains a thyatron Th , a condenser C_c shunted by a resistance R_c , and a shunt circuit containing a battery in series with a resistance R_1 of the order of 10,000 ohms. The grid transformer is controlled by a variac, and, like the plate transformer, must have a large volt-ampere rating compared with the actual power which it supplies.

The thyatron is of the negative-

under test is maintained negative and beyond plate current cut-off by the battery in the shunt circuit. When the thyatron fires the grid potential rapidly rises to the potential impressed by the transformer. While the thyatron is in the conducting state grid current to the tube under test flows into the condenser C_c and builds up a potential which causes the grid potential rapidly to recede toward a negative value. The shape of the grid potential wave is shown in Fig. 2 for the positive half cycle. The shape of this grid potential pulse can be greatly varied by changing the time constant of the $C_c R_c$ circuit. A two microfarad condenser shunted by 5,000 ohms was used in obtaining the curves of Fig. 2. For those regions of the characteristic curves where the grid current is small a higher resistance may be

This condenser, in the tests described, had a capacitance of 14 microfarads, but its size is not critical. The larger the condenser the less the distortion of the plate potential wave. A large condenser, however, causes large wattless currents through the transformer so a compromise must be adopted. Usually it is found convenient to use a large condenser for low plate potentials and a small condenser when the plate potential is high.

The path of operation on the e_p - e_g plane, as shown by a cathode-ray tube, is given in Figs. 4 and 5. The long horizontal and vertical traces give the axes of grid and plate potentials. The left vertical line is the trace given by the plate potential displaced to the left by the battery in the shunt grid circuit. At the top of this line, when

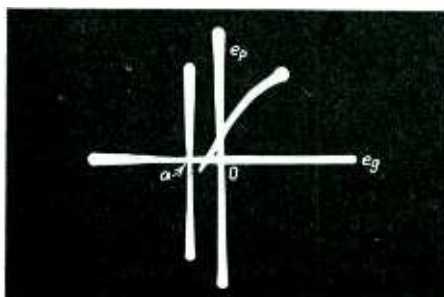

Fig. 4—Path of operation for the system of Fig. 1, in which $C_c=0$

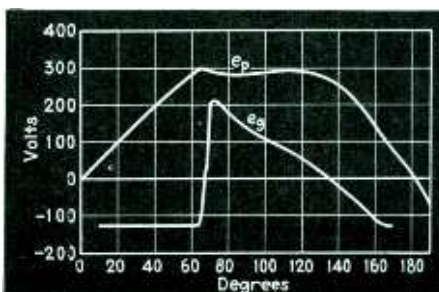

Fig. 2—Wave shape of plate and grid potentials in the system of Fig. 1

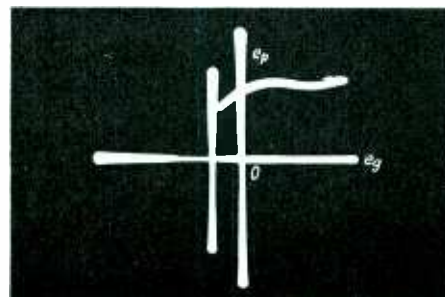

Fig. 5—Path of operation for the system of Fig. 1, in which $C_c \neq 0$

grid-control type such as the FG-57. The grid potential of the thyatron comprises a steady negative potential supplied by a battery of about 100 volts, and an adjustable alternating component supplied by a small transformer and potential divider. This alternating component of grid potential is set so that the thyatron discharges near the positive peak of the plate potential of the tube under test. A more definite time of firing of the thyatron is secured by causing the alternating potential which excites the grid of the thyatron to lag behind the potential of the main grid transformer. This is easily accomplished by inserting an inductance (not shown in Fig. 1) in the secondary circuit of the small transformer which excites the thyatron grid.

The history of the grid potential of the tube under test will now be traced. Before the thyatron conducts, the grid potential of the tube

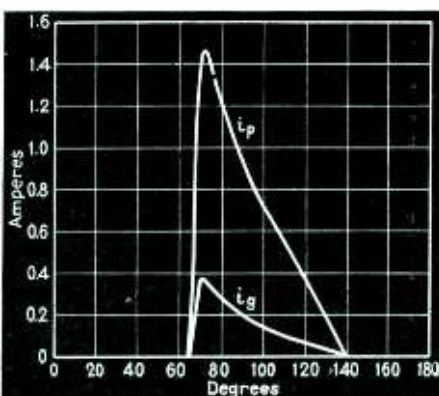

Fig. 3—Wave shape of plate and grid currents in the system of Fig. 1

used to advantage. The pulses of plate and grid currents are shown in Fig. 3.

The plate potential wave form is shown in Fig. 2, and would show a large decrease at the instant of peak plate current if a condenser were not connected across the plate transformer as shown in Fig. 1.

the plate potential is near its maximum, the thyatron fires, the point jumps rapidly to the right, and then slowly returns toward the vertical line. The trace of Fig. 4 is the type obtained when R_c is zero. Figure 5 shows the more rapid return of the grid potential to negative values when R_c is about 5,000 ohms.

The average-current meters are used merely as convenient indicators, but the wattmeters are very useful in showing the values of the plate and grid dissipations. A sensitive wattmeter can be used in the grid circuit since its potential coil is protected from large negative potentials by the thyatron. There is some advantage in including a mercury rectifier in the potential circuit of the P_g wattmeter to prevent the battery in the shunt grid circuit from passing current through the potential circuit of the wattmeter. The cathode of the rectifier would be connected to ground. Such a recti-

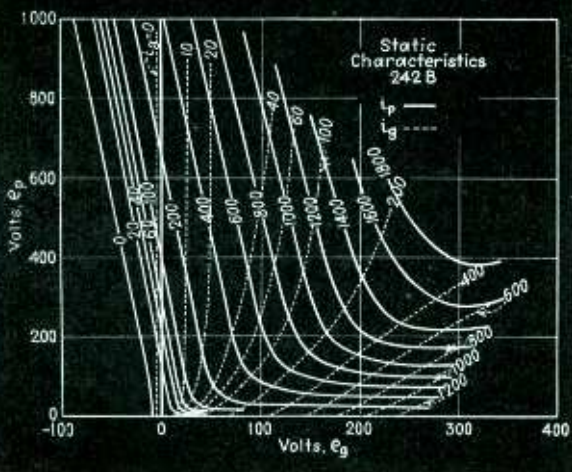

Fig. 6—Static curves for the Western Electric 242B tube

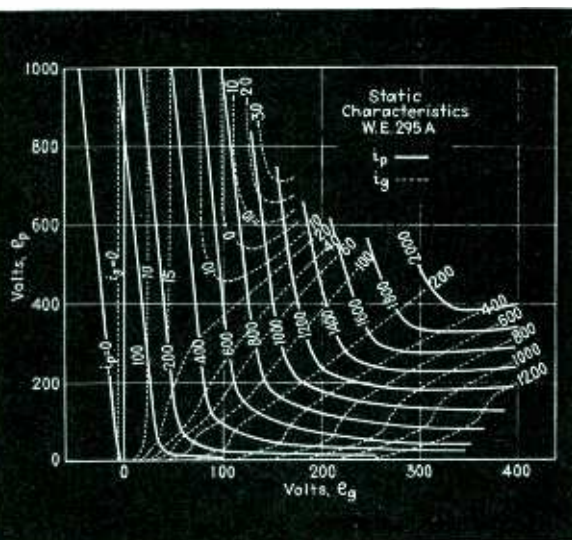

Fig. 7—Static curves for the Western Electric 295A tube

fier, although not shown in Fig. 1, was used in all work with the system. A slight error in the reading of the wattmeter is caused by the constant potential drop of about 10 volts across the rectifier, but this error is almost always negligible. Potential transformers were used instead of series resistances to step down the potentials to the wattmeters.

The measurements of instantaneous potentials are made by the potentiometer system shown in the lower half of Fig. 1. A Westinghouse rotary instrument switch connects a short-time contactor, an indicator, and a source of steady potential across the terminals between which the potential is to be measured, as for example, as shown in Fig. 1, across R_b for the determination of i_p . The short-time contactor consists of a drum of high-grade canvas bakelite, 4 inches in diameter and $\frac{3}{8}$ " thick, provided with a small segment of metal inserted in the periphery so that contact with a

brush is made for about two degrees of electrical angle. The metal segment is connected to a slip ring to which connection is made through a brush. The drum is mounted on the shaft of a small synchronous motor. Each brush consists of three separate thin strips of silver mounted side by side. The outer brush is mounted so that its position around the circumference can be changed so as to make contact at any desired instant during the cycle. The brushes are lubricated with kerosene.

The indicator of balance may be a galvanometer but a cathode-ray tube is more convenient. The primary of an input transformer, shunted by a capacitance of a few tenths of a microfarad is connected in the circuit with the contactor. The secondary potential is stepped up by one or more stages of amplifier and then applied to the vertical plates of the cathode-ray tube. The tracing beam of electrons is deflected horizontally either by a sweep circuit controlled by the 60-cycle potential, or by the 60-cycle potential directly. The time constant of the primary circuit of the transformer is of the order of a quarter cycle so that when the potentials are slightly out of balance the cathode spot traces a curve like that shown by the dot-and-dash line in the square enclosure of Fig. 1. Condenser C_d acquires a sudden charge which then discharges more slowly through the transformer primary coil. When balance is attained the figure reduces to a single horizontal straight line. The figure described is produced when the horizontal deflection is caused by a 60-cycle potential. If a sweep circuit is used the figure is somewhat different but equally useful for determining the point of balance.

The steady potentials for balancing the measured potentials are supplied by small rectifier systems of sufficient power to supply the voltmeter currents without appreciable ripple. It is convenient to have three separate d-c systems, one for the plate potential, one for the grid potential, and one for current measurement. The first two give potentials ranging from zero to several thousand volts, while the one for current measurement ranges up to 50 volts. All of these potentials are continuously variable by means of variacs in the primary circuits of the trans-

formers. Fine adjustments, consisting of small variable resistances in the primary circuits, are very convenient in setting for final balance.

A convenient procedure in taking a constant plate or grid current curve is as follows: The grid potential of the thyatron is first set so that firing occurs at, or a bit after the time of maximum potential of the grid of the tube under test. The time of contact is then set at the peak of grid potential by adjusting the position of the brush. The potential for current measurement is set and remains at the value for the curve desired. Each point on the curve is obtained by first adjusting the alternating plate and grid potentials to give balance for current, and then determining the values of e_p and e_g by setting the values of the steady potentials for balance. After balances of all three are set the switch may be turned through the several positions to check balance on all three. Generally it is convenient to obtain the entire set of plate current curves and the set of grid current curves separately.

Figure 6 shows a set of static characteristic curves obtained by the method just described for a Western Electric Type 242-B tube. This tube has an amplification factor of 12.5 and a maximum permissible plate dissipation of 100 watts. The plate is made of molybdenum. In taking the data for the curves of Fig. 6 the permissible plate dissipation was not exceeded and the grid loss was not greater than 15 watts.

When the firing of the thyatron is properly adjusted and the condenser C_c and the resistance R_c have suitable values, the ratio of instantaneous to average plate power may be 20 or more, and the same ratio for the grid may be 35 or more.

Figure 7 shows the static curves for a Western Electric Type 295-A tube. This tube has an amplification factor of 25, and a maximum permissible plate dissipation of 100 watts. The plate is made of graphite. Two familiar effects are shown by the curves of Fig. 7 which do not appear prominently in the curves of Fig. 6. Secondary emission at the grid gives regions of negative grid current in the upper part of the diagram. Secondary emission at the plate distorts the grid and plate current curves in the region of low plate potentials.

A marked instability often occurs when points in the region of negative grid currents are determined. This instability results from the negative resistance in the grid circuit, and can be eliminated by making R_c equal to zero and by reducing the resistance in the shunt grid circuit until it is less than the greatest negative resistance of the tube. It is also well to make R_1 and e_c satisfy the relation, $R_1 < \frac{E_{gm} + E_c}{-i_{gm}}$, where

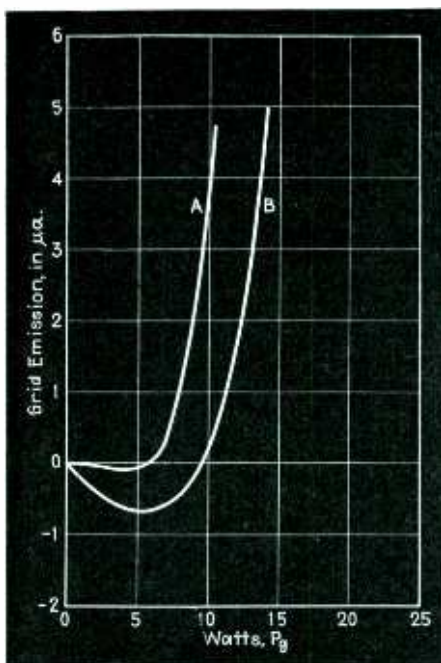

Fig. 9—Reading of microammeter in plate circuit, showing amount of gas in a triode

e_{gm} is the grid potential corresponding to the maximum negative grid current $-i_{gm}$, and E_c (a negative quantity) is the battery potential in series with R_1 in the shunt grid circuit. This relation provides that the thyatron shall not become non-conducting during the half cycle for if it did become non-conducting the transformer would lose control of the grid potential.

Oscillations in the grid circuit are often observed, owing to the negative grid resistance, which may be difficult to eliminate. These oscillations can be eliminated by neutralizing schemes or by adding a resistance in the common lead between the ground and the wire to the potential coil of the grid-circuit wattmeter in Fig. 1. This resistance should be only large enough to obtain freedom from oscillations. The best way of determining whether or not oscillations exist is to provide a cathode-ray oscillograph which shows the path of operation like that of Fig. 5.

This method for obtaining the static curves of a triode can readily be extended to measure the static characteristic curves of multielectrode tubes. For example, assume a screen-grid tetrode is to be tested at constant screen potential. The simplest method would be to make the screen circuit similar to the plate circuit. Then the alternating screen potential would be adjusted each time

for the desired constant value. The drop across the resistance in the screen circuit would give the screen current.

B. Measurement of Grid Emission

Spitzer⁸, and also Mouromtseff and Kozanowski⁹ have pointed out that grid temperature may be a limiting factor in vacuum tube operation because of primary emission of electrons by the grid. Any appreciable grid emission causes a current to flow to the plate whenever the plate potential is greater than the grid potential. During normal operation of the tube this grid emission to the plate is a maximum when the plate potential is a maximum, and hence occurs at the least advantageous time for producing power output. The result of this grid emission is to increase the heating of the plate and to reduce the efficiency of operation of the tube.

Primary grid emission depends upon the temperature of the grid and upon the material composing the surface of the grid wire, especially upon the amount of active material which may have distilled over to the grid from the cathode emitter. Because of this active film which often forms on the grid wires, grid emission may take place even at relatively low grid temperatures. Obviously the temperature of the grid depends upon the grid dissipation, upon the radiation of heat to the grid from the cathode, and upon the temperature of the surroundings, especially that of the plate.

It is possible, by means of the apparatus described, to measure the grid emission for various values of grid and plate dissipations.

The potential balancing circuit comprising the contactor, the cathode-ray tube, and the low-potential source, is connected by means of the rotary instrument switch across R_1 (10,000 ohms) in the shunt grid circuit. Condenser C_d across the transformer is removed. The brush on the contactor is now set so that contact is made when the plate potential is zero in the portion of the cycle before ignition of the thyatron, i.e., at point (a) in Fig. 4. For this measurement of grid emission it is well to increase the battery potential in the shunt grid circuit to perhaps 200 volts, and also to short-circuit the condenser C_c . The plate and grid are heated according to the magnitudes of the alternating plate and grid potentials, the power dissipations being indicated by the two wattmeters. At the time of contact the only current which can flow through

the shunt grid circuit, other than possible leakage current, is primary emission from the grid. The field between plate and grid and between cathode and grid at this instant of contact is the value of the battery potential and hence independent of the values of the grid and plate alternating potentials. The measurement of grid emission is consequently always made under the same conditions. Calculation shows that for a potential difference of 200 volts and a distance from plate to grid of 0.25 cms. the current would be limited by space charge only if the emission current were greater than 1060 microamperes per square millimeter. The field is therefore ample to draw all electrons away from the grid for a total grid emission of, say, 100 microamperes, but since with some emitting surfaces saturation is not well defined, it is best to measure the emission always for a constant field as explained above.

Figure 8 shows curves of P_g plotted against P_p for a constant grid emission of 100 microamperes. The several curves are for various types of tubes, all of the same size and rated plate dissipation of 100 watts. Curves A and B are for tubes having the same amplification factor of 12, but tube A has a molybdenum plate and tube B a graphite plate. The increase at the beginning of curve B is probably due to a change in the pattern of the electrons impinging upon the grid as the plate potential increases. It is possible that for low plate potentials some of the grid wires are strongly heated locally owing to a concentration of the electron stream to these local areas. This rising portion of the curve for low values of P_b varies in shape for different tubes of the same type and also for the same tube at different time. The portion of the curve for plate dissipations greater than 50 watts is fairly stable.

The tube for curve C has an amplification factor of 25 and a graphite plate. The tube for curve D has an amplification factor of 4.8 and a

(Continued on page 42)

Fig. 8—Relationship between P_p and P_g for constant primary current

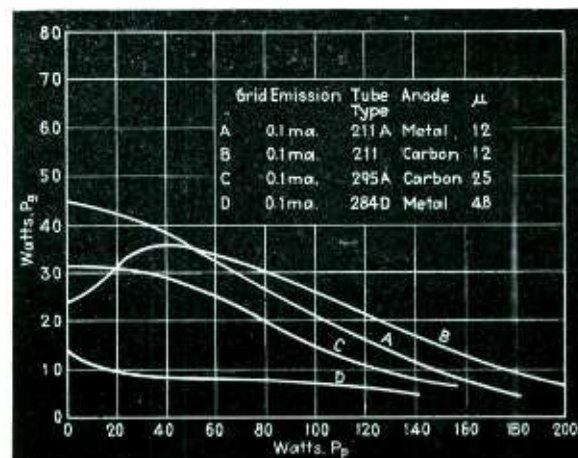

An Input Switching Console

By J. B. EPPERSON

Chief Engineer, Scripps-Howard Radio Inc.

WITHIN the past few months some form of operating console has made its appearance in many broadcast station control rooms. Due to efforts to provide the most flexible arrangements, these consoles have varied widely in design and in operating flexibility. A great many of the consoles make provision in the console for microphone switching and mixing only. Any operations such as patching into remote lines, regulating loudspeaker volume or performing emergency patching operations require that the operator on duty leave the console to perform the indicated operations at another point, usually at equipment mounted on a relay rack in another part of the control room. A still later type of speech input console houses all the studio equipment from pre-amplifiers to monitoring amplifiers in the operating console. While this type of console has advantages from the standpoint of compactness and for economic reasons, it certainly offers complications to the engineer who has to service it in an emergency and it does not offer the flexibility demanded by the larger broadcast stations.

The input switching console described in this article provides all of the advantages of the rack and panel type equipment as to flexibility and ease of servicing. All of the controls used for normal operation are within easy reach of the operator including all patching operations. Program and audition switching keys have been reduced to a minimum in number yet any switching operation with the exception of remotes may be performed without the use of patch cords. Loudspeaker talk-back is provided without the use of relays. A simple remote cue system is used which allows two remote lines to be set up in advance. Both lines are fed the program being broadcast for a cue to the remote operator. When it comes time to put the remote program on the air, the operation of one switch automatically reverses the line.

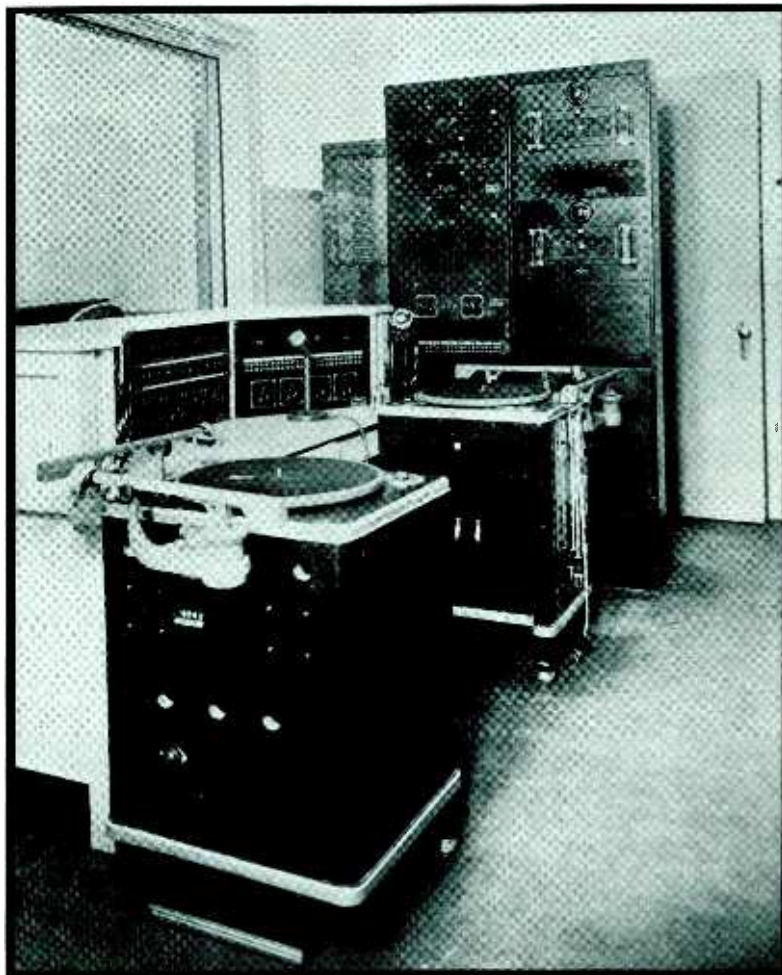

Fig. 1—View of WMPS control room showing arrangement of input console, turntables, and amplifier racks

The design of the console cabinet centers around the use of standard rack and panel type equipment. The overall height is 40 inches. The height from the floor to the top of the operating table is 29½ inches, and the length measures 62½ inches. The constructional details are shown in the photographs. The lid to the console is hinged and may be opened for access to the equipment. The back, down to table level, slides into grooves and when necessary, the top and back may be removed together as a unit.

The equipment described herein was installed at station WMPS, Memphis, Tenn., in January, 1938. The photographs were taken after the

equipment was set up and in operation.

The four channel program mixer is used for fading and adjusting the volume for all input programs which are being broadcast. These controls are numbered from left to right and are spoken of as mixing control 1, mixing control 2, mixing control 3 and mixing control 4.

The program selector key panel is made up from ten Western Electric key switches. With the exception of the two end keys, Nos. 1 and 10, alternate keys of this panel are mechanically-yoked so that two keys operate as one. This arrangement eliminates the necessity for relays since the second key in each position

is isolated from the microphone switching key and it may therefore be used directly for loudspeaker cut-off and signal light control circuits.

The four mechanically-yoked keys, which are called bar keys, operate in conjunction with the four mixing controls located in line with and directly beneath the switches. Switch 1 works with mixing control 1, switch 2 works with mixing control 2, etc. (See Fig. 3.)

The two transcription turntables are connected through the neutral positions of bar keys 2 and 3 direct to the inputs of mixing controls 2 and 3 respectively. In this manner, transcription turntable 1 is normally connected to mixing control 2 and transcription turntable 2 is normally connected to mixing control 3. Operating bar key 2 or 3 to an "up" or "down" position automatically removes the transcription turntable from the mixing control in question and instead connects the input provided for the position to which the key is switched. This arrangement allows the announcer on duty to use both turntables without the necessity for operating any switch other than that for his announce microphone. When this microphone is turned on by the operation of bar key 4 to its "down" position, the control room microphone is connected to the input of mixing control 4 and the operator uses this control to adjust the gain to the proper level. Simultaneously with the operation of bar key 4 to

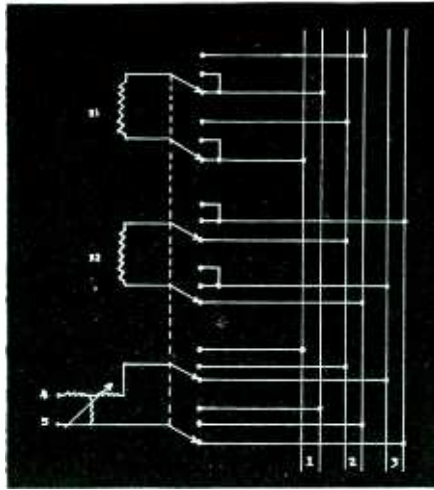

Fig. 2—Constant impedance loudspeaker selector circuit

its "down" position, the control room speaker is turned off and a warning light is turned on outside the control room door. The other microphone switches operate in a similar manner and perform similar functions.

The single key on the right-hand end of the switching panel operates in conjunction with bar key 2 and functions as a pre-amplifier input selector key. Therefore, when switching to the lobby microphone, this key must be operated to its "up" position along with bar key 2. In a similar manner, when switching to microphone B-2, this key must be operated to its "down" position along with bar key 2. With this switch, four pre-amplifiers are made to do the work of six. The single end key and bar

key 2 must be kept in their neutral positions at all times except when they are actually in use.

The single key on the left-hand end of the switching panel is a two-position remote key with an automatic line reversing feature. The two input positions of this key are brought out to jacks on the line jack panel which are designated to correspond to the key positions. In setting up for an incoming remote, a patch cord is used to connect Remote 1 jack to any desired line. As long as the remote key is not operated to the Remote 1 position, the program being broadcast from the studio is fed back on the line for a cue to the remote operator. When the key is operated to its "down" position, the program cue is disconnected and the remote line is connected to mixer 1 input. When two remote programs are to be broadcast consecutively, the second remote is set up by patching from the Remote 2 jack to the desired incoming line. The program cue being fed to the second remote through Remote 2 position is not affected by the operation of the remote switch to the Remote 1 position and the cue continues to be fed to the second remote until such time as the remote switch is operated to the Remote 2 position. Bar key 1 must remain in neutral position during the broadcasting of remote programs. A complete wiring diagram of the program-audition switching panel is shown.

Fig. 3—Closeup of the input console showing location of important components

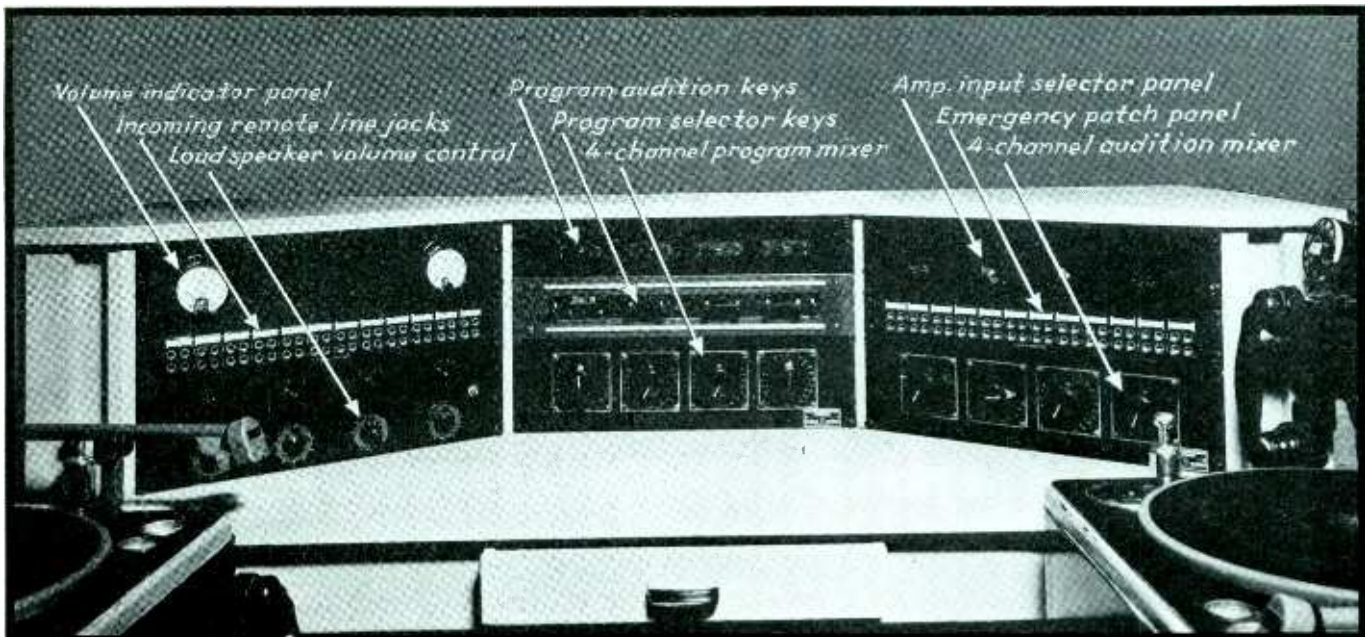

For each of the four bar switches on the ten key program selector panel, there is located on the audition selector panel just above, a program-audition selector key called audition key or audition switch. Each of these switches will normally set to the extreme left, thereby connecting the output of the associated bar key, located just below any particular key, to the input of the corresponding mixing control. When any one of these audition keys is operated to the right, the output of the corresponding program key below is changed from the program mixing control input to the audition mixing control input with corresponding number. Therefore, to audition any channel or channels, it is only necessary to operate the audition switch from extreme left to extreme right for the channel or channels desired for audition purposes. The main program or bar key will then operate the same for audition as for broadcast, and the signal lights and loudspeaker cutoff circuits will function the same. The only difference between the operation of a broadcast program and an audition program, after the audition key has been set, is that the operator controls the volume with the audition mixing controls for the channel or channels in

use instead of the program mixing controls.

The audition program can be heard on the control room speaker by operating the control room speaker selector switch to position 2. In the same manner, the audition program may be heard on any of the associated speakers in the offices, audition room or lobby by setting the individual speaker selectors on position 2.

At times it will be desired to audition a program input connected to the lower position of a bar key while the same key is tied up with its upper position being broadcast. For instance, it might be desired to audition transcription turntable 2 while broadcasting NBC. When broadcasting NBC, bar key 3 is operated to its up position.

To audition turntable 2 requires bar key 3 be in its neutral position. This is made possible by operating audition key 3 to its center or neutral position. This operation isolated NBC from the bar key and connects it direct to program mixer 3 input. At the same time, the output of the bar key is connected to audition the same as though the audition key had been switched all the way to the right. Thus: to audition turntable 2 when broadcasting NBC we would simply bring audition key 3 to neu-

tral, return bar key 3 from its "up" position to neutral and control audition volume by means of the audition mixing control 3. The volume of the NBC program being broadcast would still be controlled by program mixing control 3.

When the audition is finished and it is desired to return the controls to normal, it is necessary to first return bar key 3 to the NBC position. Then the audition key may be returned from neutral to its normal operating position on the extreme left.

In a similar manner all audition keys are connected so that the program input on the lower half of any bar key may be auditioned while the program input on the upper part of the key is being broadcast. The neutral position of any audition key is never used unless the program input on the top position of the associated bar key is being used for broadcast.

Loudspeaker Control Circuits

On the loudspeaker control panel there are four selector switches and four volume controls. The selector switch and volume control for each speaker are in line vertically. Reading from left to right Nos. 1, 2, 3 and 4 sets of controls are for speakers

Fig. 4—Terminal data for input switching panel (see opposite page for connection)

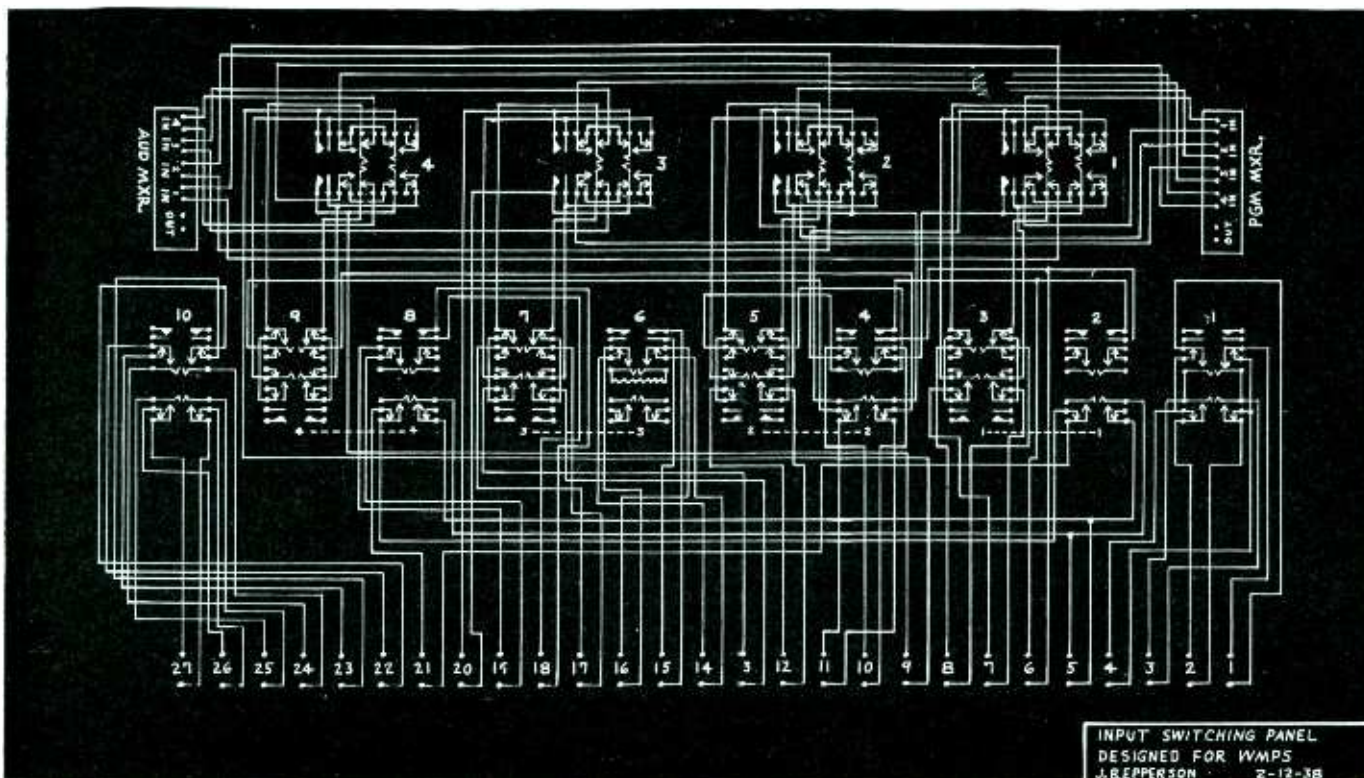

INPUT SWITCHING PANEL
DESIGNED FOR WMPS
J. BEPPERSON 2-12-38

located in the front lobby, rear lobby, studio A and control room respectively. By means of the 1, 2 and 3 positions on each selector switch, each speaker may be switched independently across local (the program being broadcast) audition, and NBC respectively. Three other speakers, with a similar set of controls for each speaker, are provided in the client's audition room and in two of the offices. The seven speakers each have 500 ohm voice coil connections. In the wiring diagram for the speaker control circuits, the 500 ohm speaker voice coils connects to terminals 4 and 5 or to the output of the 500 ohm T pad volume control. The resistors R_1 and R_2 are 500 ohms each and serve to maintain a constant

are operated in pairs to form 24 jack outlets. This panel is used almost exclusively for incoming remote telephone lines. Two jack pairs are used for the Remote 1 and Remote 2 input connections to the remote key on the input switching panel. Other pairs are used for telephone patching and for making multiple connections.

Volume Indicator Panel; Patch Panel

This panel contains two volume indicator meters. The one on the right-hand end of the panel is connected across the output of the line amplifier which feeds the transmitter and is used for continuous visual monitoring of the program being broad-

key circuit, the output of a similar pad connected in the NBC line circuit and for the two RCA transcription turntables. In the failure of equipment such as mixing controls, key switches, or pre-amplifiers, this panel provides a means for continued operation by allowing substitute equipment to be patched in for replacing that which has failed. The terminations provided are also an aid for testing various parts of the equipment while it is in operation.

Amplifier Input Selector Panel

The input circuits of the local, audition and NBC monitoring amplifiers are brought through the variable arms of these switches and wired in such manner as to provide a means for an immediate interchange of any three of the amplifier input circuits. When interchanging amplifiers in an emergency it is not necessary to switch the output circuits since the output circuit of each of the three amplifiers used is available by means of the speaker selector switches for the individual speakers.

The fourth switch on this panel serves as the VI selector switch. It is so wired that the VI meter may be placed across the transmitter line, emergency line, NBC line, audition channel and across a jack on the line panel which makes it possible to patch the meter into any of the circuits brought out to jacks.

The studio amplifier equipment, all RCA, consists of four type 41-B pre-amplifiers, one type 40-C line amplifier, two type 94-C monitoring amplifiers and one type AA-4194B monitoring amplifier.

(Continued on page 73)

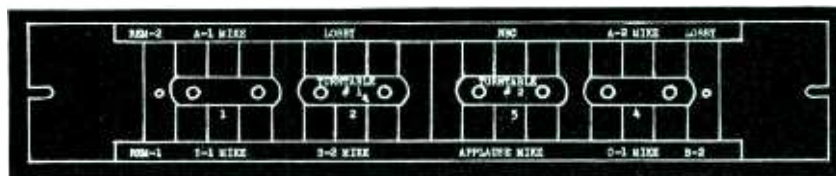

Fig. 5—Arrangement of keys on input switching panel

load on any two of the three channels while the third is connected to the speaker voice coil. This circuit makes use of a Yaxley three section, non-shortening type rotary switch. The wiring of all the selector circuits are identical with the one shown and each switch connects to channels 1, 2 and 3 in the same manner. Thus, each channel has an effective load resistance of $500/7$ or 71.4 ohms. A 70-15 ohm matching transformer is provided for each channel to properly match it to the 15 ohm output of the associated monitoring amplifier.

Incoming Remote Line Jack Panel

This panel contains 48 jacks which

cast. This meter works in conjunction with the VI attenuator located on the 40-C line amplifier.

The VI meter on the left-hand end of the panel is normally connected to the output of the audition amplifier through the VI selector switch. This meter is used primarily for monitoring and audition program. By means of its associated selector switch, however, it may be used to measure the level on other channels.

This patch panel forms a junction where the pre-amplifier output circuits and mixing control input circuits terminate. It also forms a terminating point for the output of a 10 db pad connected in the remote

1. Through line repeating coil to Remote 1 jack on line panel
2. Through line repeating coil to Remote 2 jack on line panel
3. To input of 10 db remote pad
4. Bridges across output of "local" monitoring amplifier. (Feeds remote cues)
5. To studio A warning light in series with secondary of 6.3 volt transformer (Same transformer for A, B and C)
6. To studio B warning light in series with secondary of 6.3 volt transformer
7. To output of 10 db remote pad
8. To output of pre-amplifier 4

9. To output of pre-amplifier 3
10. To output of pre-amplifier 2
11. To output of pre-amplifier 1
12. To output of RCA turntable 1
13. To output of RCA turntable 2
14. To lobby speakers
15. One side of terminal 15 to ground. Other side in series with $1\frac{1}{2}$ volt dry cell to center tap of carbon microphone transformer primary. (Carbon microphone used for applause in lobby only)
16. To "local" monitoring amplifier output
17. To 200 ohm secondary of carbon microphone transformer

18. To studio C signal light in series with 6.3 volt transformer secondary
19. In series with one side of control room speaker volume control and voice coil
20. To NBC line through repeating coil and 10 db pad
21. In series with one side of studio A speaker volume control and voice coil
22. To input of pre-amplifier 2
23. To studio A-1 microphone
24. To studio B-2 microphone
25. To lobby inductor microphone
26. To control room microphone
27. To input of pre-amplifier 1

National Academy Award



Dr. Willis R. Whitney



DR. Willis Rodney Whitney, General Electric vice-president in charge of research, was awarded the Marcellus Hartley Gold Medal by the National Academy of Sciences at its annual meeting in Washington, April 26, "to mark the appreciation of the National Academy of Sciences for eminent

services to the public, performed without a view to monetary gains and by methods which in the opinion of the Academy are truly scientific."

Dr. Whitney's pioneering work in making science available to industry by his creation and development of the General Electric research laboratory is

probably his most notable achievement.

Following his graduation from Massachusetts Institute of Technology in 1890 and from the University of Leipzig in 1896 where he was awarded the degree of doctor of philosophy, Dr. Whitney became an instructor at M.I.T.

Power Tube Characteristics

[Continued from page 37]

molybdenum plate. The differences in the several curves are, of course, mostly due to the differences in grid structure and in the size of grid wire. Data on the grid wires are not given because the purpose of this section is not to present data for specific tubes but to show that the curves for different tubes do vary considerably and to describe the method of obtaining the curves.

C. Indication of Gas Content

If the plate transformer be reversed the path of operation shown in Fig. 5 is inverted. In this condition the path never encroaches upon the region where plate current flows but does traverse the region of grid current flow below the horizontal axis. Grid dissipation can be controlled by the grid potential applied,

and is given by the wattmeter in the grid circuit. A microammeter placed directly in the plate circuit indicates primary grid emission when P_g is sufficiently great, or positive ion current if P_g is low. Since the microammeter is directly in the plate circuit with no interrupter in series with it, its indication is an integral of the instantaneous plate current over a cycle. No electrons from the cathode can reach the plate at any time. When the plate potential is greater than the grid potential, primary grid emission if any, flows to the plate. This occurs mostly during the portion of the cycle when the grid potential is negative and hence the grid circuit is zero. When the grid potential is positive grid current flows and ionization takes place if there is an appreciable amount of gas present. During this portion of the cycle the plate potential is negative and hence the plate attracts the positive ions giving a current in the opposite direction to the grid emission current. An indication of gas content in the tube can be obtained without much grid

emission by noting the deflection when P_g is suddenly increased and decreased so that the grid has not sufficient time to heat up to the emitting point.

Figure 9 gives the reading of the microammeter plotted against P_g for two tubes. Curve A is for a satisfactorily hard tube, while curve B is for a tube of identically the same structure but containing a greater amount of gas, as shown by the negative deflection. The amount of gas shown by curve B is not sufficient materially to affect the emission of the tube or its operating characteristics.

REFERENCES

- ¹H. N. Kozanowski and I. E. Mourmontseff, "Vacuum Tube Characteristics in the Positive Grid Region by an Oscillographic Method," *Proc. I.R.E.*, 21, 8, 1082 (1933).
- ²G. Gramaglia, "The Plotting of Characteristics of Transmitting Tubes (by Matteinis Method)," *Alta Frequenza* 4, p. 406, August, 1935.
- ³Presented before the Washington meeting of the I.R.E. and U.R.S.I., April, 1937.
- ⁴E. L. Chaffee, "Power Tube Characteristics," *Electronics*, July, 1937, p. 30.
- ⁵E. E. Spitzer, "Grid Losses in Power Amplifiers," *Proc. I.R.E.*, 17, 6, 985 (1929).
- ⁶I. E. Mourmontseff and H. N. Kozanowski, "Grid Temperature as a Limiting Factor in Vacuum Tube Operation," *Proc. I.R.E.*, 24, 3, 447 (1936).

New ATTENUATOR



4-Finger Beryllium
Copper Contact

Famous IRC Insu-
lated Resistors

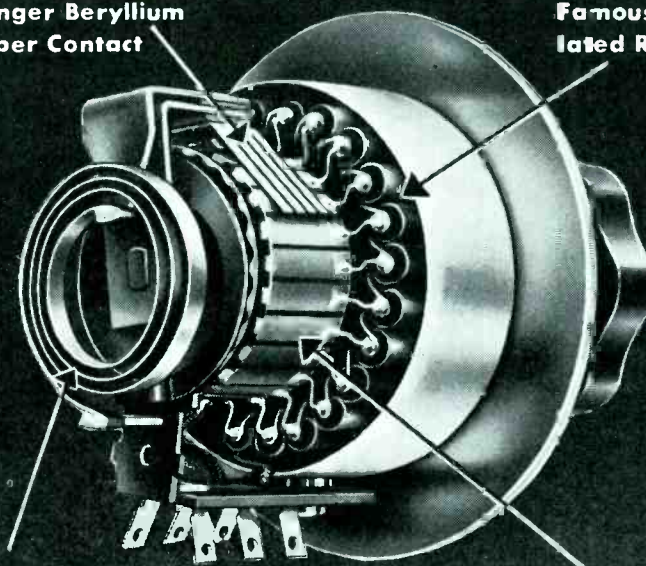

"Silent Spiral"
Clock Spring
Connector

Molded Commutator
Switching Mechanism

**REVOLUTIONARY
NEW DESIGN**

**EXCEPTIONALLY LOW
NOISE LEVEL—
MAINTAINED
IN SERVICE**

An original low noise level maintained in actual service is made possible in the new IRC Type A-21 20-step Attenuator by its unique design.

The conventional stud type switch is replaced by a molded motor commutator with conducting segments of polished, hard-drawn copper molded in phenolic. Each finger of the multi-finger copper contact operates independently, insuring smooth, noise-free action. One series pressure contact is definitely eliminated by a "Silent Spiral" clock spring connector similar to that pioneered by IRC more than two years ago in the Type CS volume controls. Throughout, the Attenuator is constructed for long, trouble-free service.

The Attenuator is 2" long by 2" diameter. The attenuation range is linear from 0 DB to 45 DB in steps of 2½ DB, tapering from 45 DB to infinity in the last two steps. It is made with or without detent action. Standard terminal impedances are 50, 200, 250 and 500 ohms. Other variations of ladder or step potentiometer networks are available. The unit is protected by a tight-fitting removable aluminum cover. Write for catalog.

INTERNATIONAL RESISTANCE COMPANY

403 NORTH BROAD STREET, PHILADELPHIA, PA

In Canada, 187 Duchess Street, Toronto, Ontario

**MAKERS OF RESISTANCE UNITS OF MORE TYPES, IN MORE SHAPES, FOR
MORE APPLICATIONS THAN ANY OTHER MANUFACTURER IN THE WORLD**

TUBES AT WORK

Surface Hardening—A New Job for Transmitting Tubes

GEORGE BABAT
MICHAEL LOSINSKY
Leningrad, Russia.

IN THE MAJORITY of steel parts in modern mechanical engineering the whole load is carried by the peripheral zones alone, which at the same time are exposed to friction as, for instance, in piston pins, axle journals, tappet shafts and wheels, slide blocks, tires, cylinders, etc. It is necessary therefore to harden these peripheral zones only, because the hardening of the whole section results in loss of tenacity between interior layers of material, which in most cases is highly undesirable.

Of all known methods of surface hardening one of the most perfect is that of treating steel with eddy cur-

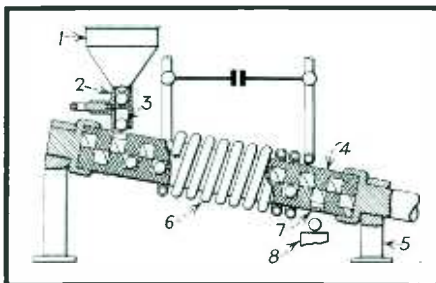

Fig. 1.—Only the surface layer of steel balls is hardened while interior core retains its tenacity—just what is needed for ball bearings. Balls fed through funnel 1 are admitted one by one, by means of trigger 2-3, into the tilted porcelain tube 4 which rotates in bearings 5. In rolling from the one end of the tube to another through the helical channel provided in the tube the balls pass the magnetic field of h-f coil 6 and then fall through opening 7 into cooling liquid 8.

rents. The part is inserted in the magnetic field of a coil supplied with high frequency current (10,000 to 1,000,000 cycles). The eddy currents induced cause the temperature of the outer layer to rise to the hardening point. After being heated the part is plunged immediately in a cooling medium, such as water or oil. As a result of this treatment the peripheral layer acquires a structure characterized by high grade of hardness and the ability of withstanding friction, while the interior retains its original tenacity. By varying the frequency and the power input to the coil it is possible to con-

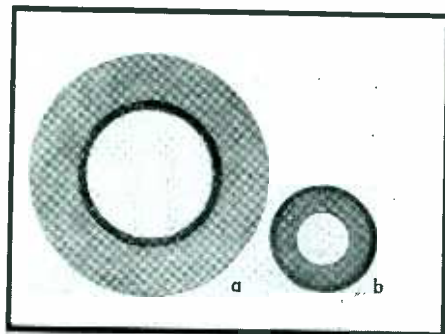

Fig. 2.—Cross section of surface hardened steel tubes: tube (a) has been heated inwardly by inserting the coil into the tube; in tube (b) the external surface has been hardened by inserting tube in coil.

trol the thickness of the hardened layer and its structure.

Surface hardening by means of high frequency eddy currents has advantages that are quite unobtainable by other ways: no scale is built up, the parts are not affected by warping, the hardened layer is closely bound with the bulk of material and the transition is gradual, the quality of the work does not depend on the skill of the worker, that is, the results obtained are wholly reproducible.

When due to skin-effect, eddy currents circulate in a thin surface layer, the thickness of which is determined by the frequency and the electrical and magnetic properties of material. The depth of penetration is given by

$$p = 3570 \sqrt{\frac{\rho}{\mu f}}$$

ρ = resistivity of the material, ohm-cm,

μ = permeability = 1 for nonmagnetic materials,

f = frequency, cycles per second.

For example: $\rho = 100 \times 10^{-6}$

$$\mu = 1000$$

$$f = 500,000$$

$$p = 0.016 \text{ mm.}$$

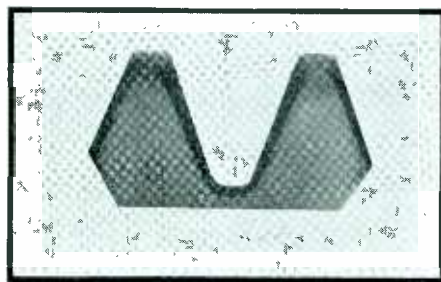

Fig. 3.—Rack hardened by means of h-f eddy currents (cross section)

In this thin layer is concentrated all of the heat generated. After the temperature has reached a critical point, the magnetic permeability of steel becomes equal to 1 and the depth of penetration increases 10 to 40-fold. The efficiency of the induction heater coil suddenly drops, the rate of heating decreases and the generation of heat occurs in deeper layers. As the hardening temperature is somewhat above the critical point, overheating is eliminated. It is also evident that the thickness of the hardened layer, owing to thermal conductivity of steel, is not determined by the depth of penetration, but only by the power input to the heating coil and the hardening time. Even with very high frequencies thick hardened layers can be obtained. Less power input with longer heating time, yields thicker layers.

The equipment for surface hardening by use of eddy currents consists of two principal parts: the hardening device including the heater coil and the high frequency generator. The hardening device is essentially an arrangement

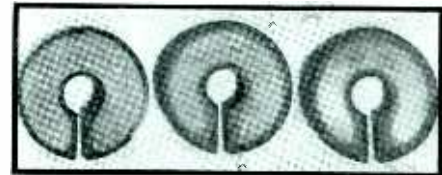

Fig. 4.—Part of complicated cross section, which was hardened using the uniform magnetic field of a simple circular coil.

for automatically supplying parts to the heater coil. Its design depends on the kind of parts to be treated. The arrangement shown in Fig. 1 is a prac-

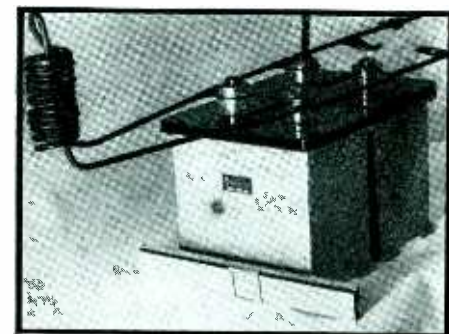

Fig. 5.—Heating coil used for hardening of interior surfaces of steel tubes

tical example of a feeding device in combination with the heater coil for surface hardening of steel balls. It is interesting to note that with parts of most complicated shape uniform heating may be obtained by means of quite simple configuration of the heating coil, i.e., by means of the uniform magnetic field. Figures 2, 3 and 4 show various samples of parts hardened in circular coils.

For the purpose of generating high frequency currents rotary machines or

THAT'S LIFE!

15-20-25 THOUSAND HOURS
is common experience with W.E. tubes

Western Electric Vacuum Tubes are engineered and manufactured to give a maximum number of hours' life for every type of service. Hence such typical records as these:

One 50 KW broadcasting station is still using its first set of Western Electric 212E tubes after

21,500 HOURS



Two other 50 KW stations are still operating their first Western Electric 266B rectifier tubes after

17,000 HOURS



Western Electric 242 type tubes have been operated in Sound Picture Amplifiers for more than

21,000 HOURS



Western Electric 287A tubes are still operating in frequency control circuits after continuous service of

24,000 HOURS



A 1 KW broadcasting station has operated each of two Western Electric 279A vacuum tubes for more than

18,000 HOURS

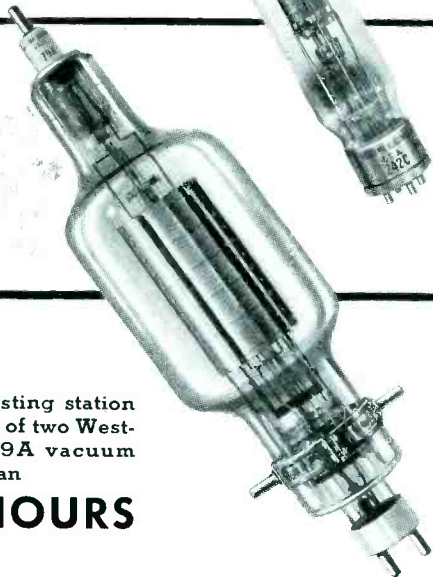

Western Electric 240B double-ended water-cooled tubes have been used in short-wave transatlantic service for more than

11,000 HOURS

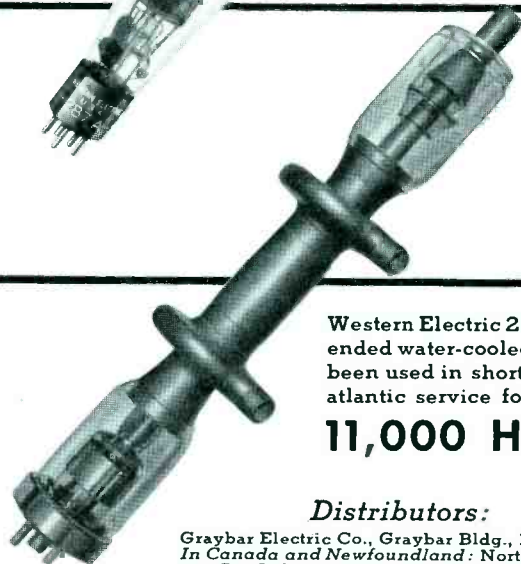

Distributors:

Graybar Electric Co., Graybar Bldg., New York.
In Canada and Newfoundland: Northern Electric Co., Ltd. In other countries: International Standard Electric Corp.

Western Electric
ELECTRONIC EQUIPMENT





Is your Ferranti File Complete?

Up to date bulletins are now available on each of the following six lines:—

- (1) Super Series A Line—Audio
- (2) Ultra Series B Line—Audio
- (3) Aero Series C Line— { Audio
Aircraft and Portable
- (4) Hum Free—Power Units
- (5) Low Cost—Power Units
- (6) Electrostatic Voltmeters

Ferranti Electric Inc.
R. C. A. BUILDING, NEW YORK, N. Y.

Gentlemen: Please send me, without any obligation, bulletins on

NAME.....
 TITLE.....
 COMPANY.....
 ADDRESS.....

vacuum tube oscillators can be employed. For many reasons preference is given to the latter. Our experiments showed that in case of complicated form of parts, such as shown in Figs. 3 and 4, better uniformity of hardened zone is obtained with higher frequencies of the order of 100-1000 kilocycles. To build rotary machines to the purpose of generating such frequencies is quite impossible. For parts of simple shape and big size (such as axle journals) frequencies as low as 1000 cycles may be used. Rotary machines could be employed in that frequency range, but even in this case vacuum tube oscillators must be preferred because of their many advantages as compared with rotary machines with regard to lower installation costs, absence of noise and vibration, etc.

The heat conductivity of steel varies from 0.025 to 0.017 cal/cm². degree C. With a temperature gradient of 1 deg. cm. the maximum density of power flux is 0.78 w/cm². For surface hardening temperature gradients of 500 to 1000 deg. cm. are necessary. Therefore the power flux required ought to be 300-700 w/cm². The efficiency of induction heater, especially in case of small size of parts, is 60-70 per cent. Hence the power required from the h.f. generator is of the order of 1 kw on 1 cm² of the surface area of part to be treated. For parts such as piston pins, crankshaft journals of automobiles, etc., powers of the order of 100-200 kw will prove sufficient. Modern vacuum tube oscillators can be designed without difficulty for power output of that magnitude. Thus a new field of use for power oscillator tubes is opened.

(Continued on page 50)



Fig. 6.—The authors with a high frequency vacuum tube generator with power output 20 kw used for hardening of steel parts

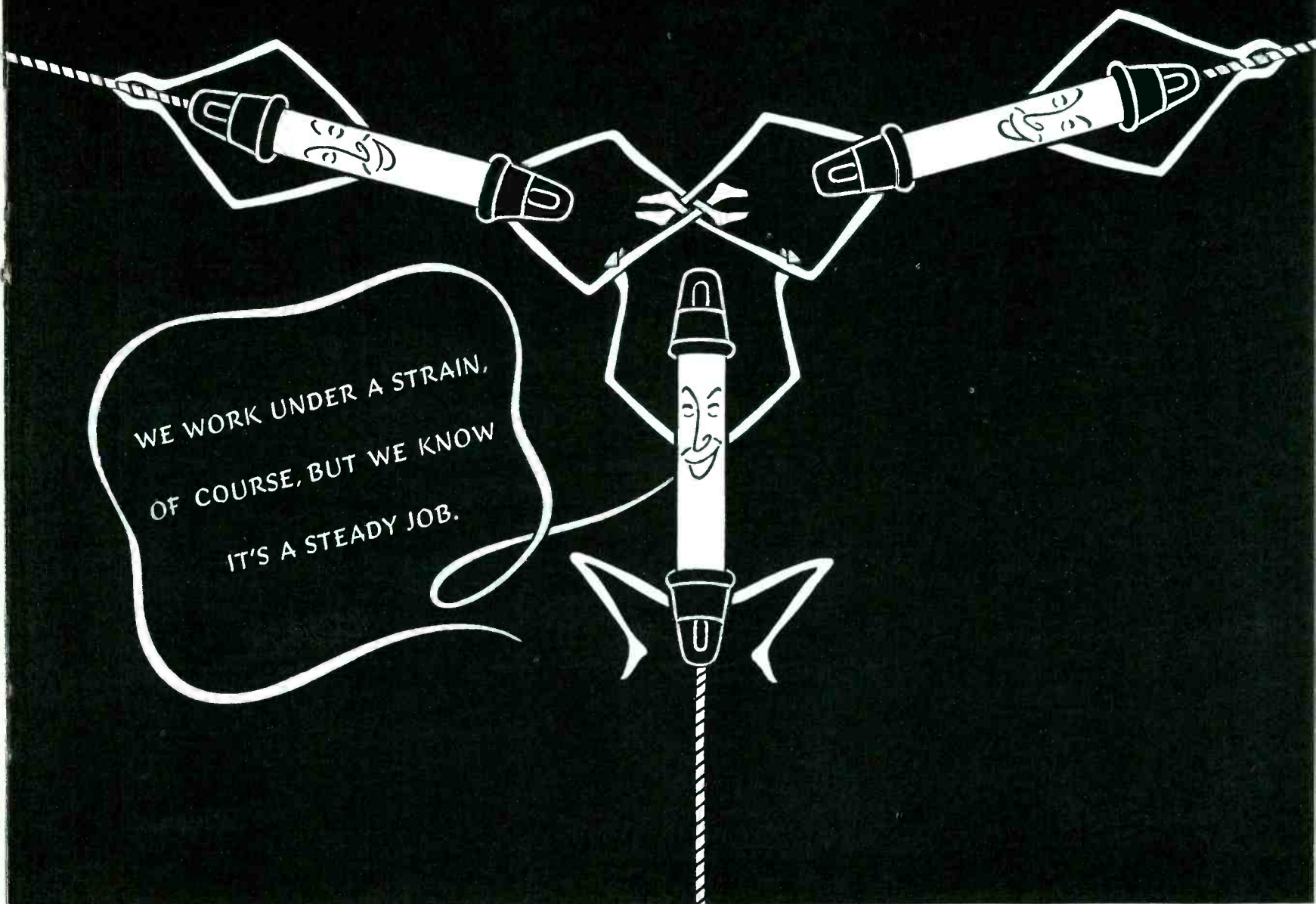

ISOLANTITE* strain insulators need not worry though they work under tension; their rugged constitution prevents them from cracking. And they know the work is permanent, because Isolantite insulators give full satisfaction in every high frequency application.

High mechanical strength is a characteristic of Isolantite insulators. They can be used to advantage under tension or compression—even small cross-sections have high resistance to breakage. They work efficiently, too, for their low power factor keeps dielectric losses at a minimum and permits maximum power radiation. Exposure to the elements has little effect on their properties. Vitrified

at high temperatures, they do not absorb moisture.

Standard insulators can be used for many applications. When special insulators are needed, Isolantite engineers will cooperate with customers in the design of the most economical forms.

*Registered Trade-name for the products of Isolantite Inc.

ISOLANTITE INC.

CERAMIC INSULATORS

Factory: Belleville, N. J. • Sales Office: 233 Broadway, New York, N. Y.

Announcing

MONEL STRIP

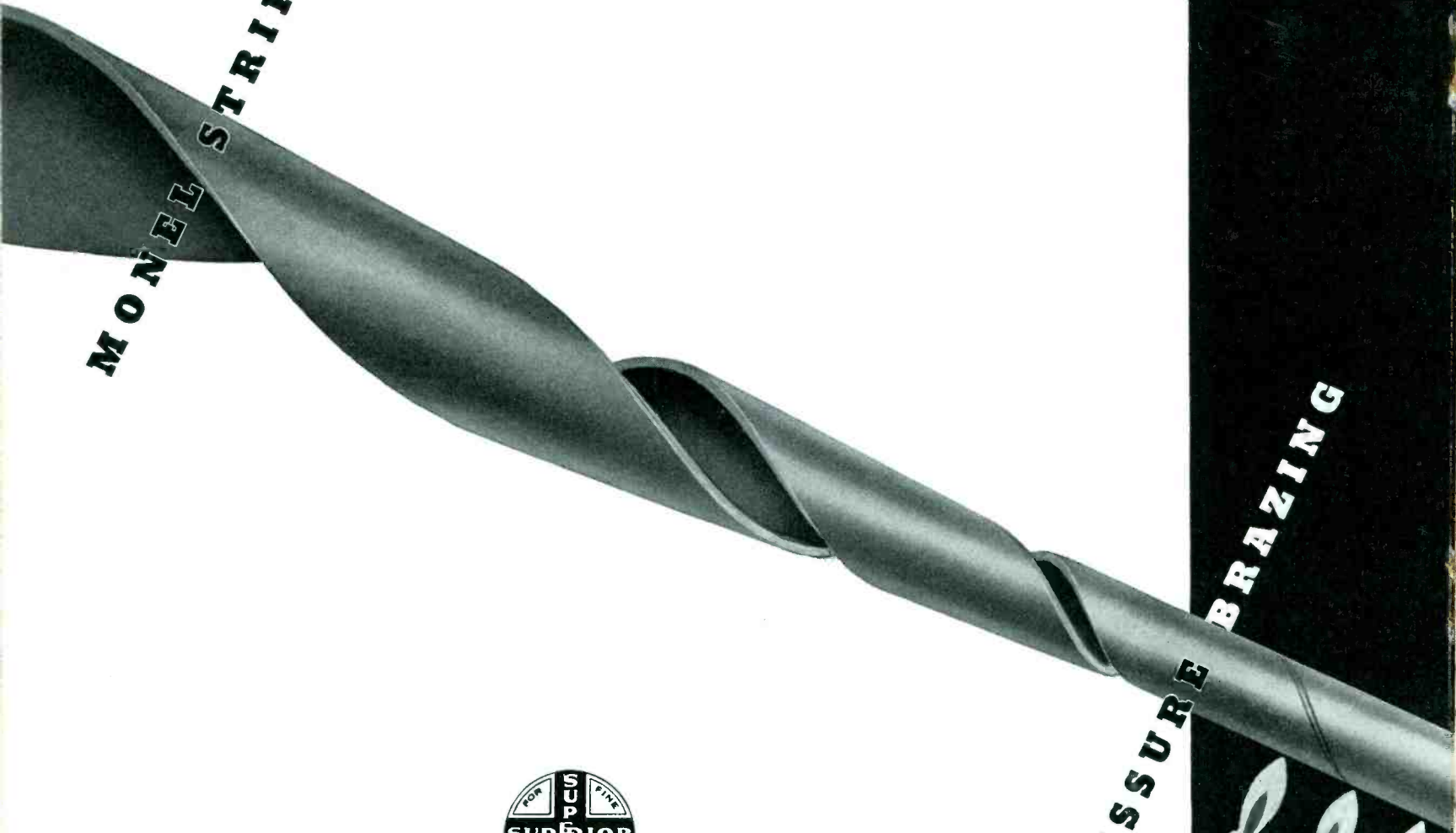

PRESSURE BRAZING



BRAWN Monel Tubing is manufactured in the U. S. by Superior Tube Company exclusively and is looked upon as an outstanding contribution to industry. It is available in sizes from $\frac{1}{16}$ " OD (.062") x .007" wall to $\frac{5}{8}$ " OD x .049" wall . . . Samples of Brawn tubing for inspection and test will gladly be sent you upon request, together with quotations on any quantities. Please address—Superior Tube Company, Norristown, Pa.

MANUFACTURERS OF SEAMLESS AND LOCKSEAM CATHODE SLEEVES AND FINE SMALL TUBING IN VARIOUS METALS AND ALLOYS.

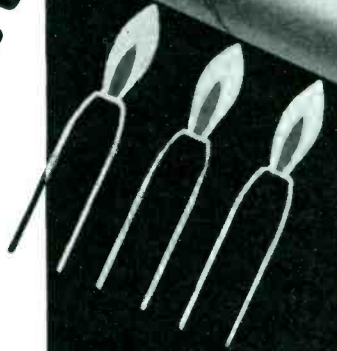

SUPERIOR

BRAWN[★] MONEL TUBING

a NEW PRODUCT of

VITAL INTEREST TO ALL USERS OF FINE SMALL TUBING

There's nothing new about tubing formed by spiraling strip metal, but here is an utterly new process and product—tubing with practically all the physical characteristics of seamless. A patented method of Pressure Brazing, then Cold Drawing produces a homogeneous tube wall which approximates seamless in tensile, compression and bursting strengths. From original strip to a very fine tube its manufacture is accomplished without the usual percentage of waste, without the usual amount of labor, without the usual time element. These savings, passed on to the user, provide many industries with better tubing than formerly was available within their price limits.

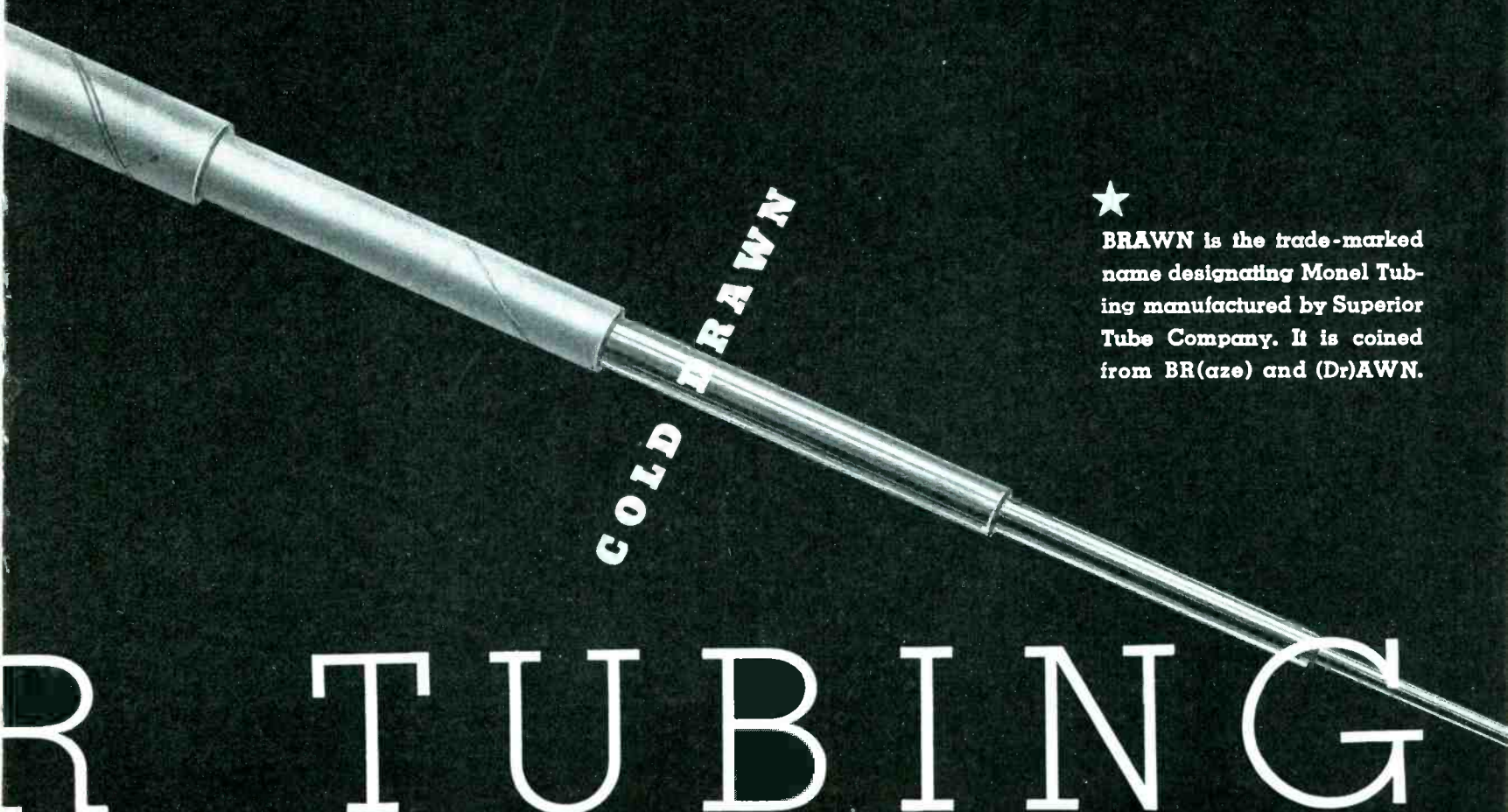

BRAWN is the trade-marked name designating Monel Tubing manufactured by Superior Tube Company. It is coined from BR(aze) and (Dr)AWN.

R TUBING

★ **NEW** ★

249 ENGINEERING & ARCHITECTURAL SYMBOLS CONSOLIDATED ON ONE CHART

FROM FREDERICK POST **FREE**

This brand new copyrighted 22" x 35" chart, first and only one of its kind, has the everyday and most of the "hard-to-find" architectural and engineering symbols all on one side—alphabetically arranged.

It is free to you if you are a regular member of an architectural or engineering organization or firm maintaining a drafting department. No obligations—A POST good will gesture.

A "Double-Duty" Instrument

The Big Bow compass with only a 5" overall measurement easily and accurately makes a 6 3/8" circle. A finely balanced "double-duty" instrument for hard use. Try one on approval.



[Limited space permits only partial illustration of chart]

Birmingham—James A. Head, Inc. • **Boston**—Boston Blue Print Co. • **Buffalo**—Buffalo Blue Print Co. • **Chicago**—The Frederick Post Co.; Horders, Inc. **Cleveland**—The City Blue Printing Co. • **Dallas**—The Rush Co. • **Dayton**—The Gem City Blue Print & Supply Co. • **Denver**—H. R. Meininger Co. **Detroit**—The Frederick Post Co. • **Fort Wayne**—Fort Wayne Blue Print & Supply Co. • **Fort Worth**—Majestic Reproduction Co. • **Houston**—Gulf Blue Print Co. • **Indianapolis**—Indianapolis Blue Print & Litho. Co. • **Kansas City**—Western Blue Print Co. • **Knoxville**—Sehorn & Kennedy • **Los Angeles**—Stationers Corporation • **Milwaukee**—Frederick Post Co. of Wis. • **Oklahoma City**—The A. & E. Equipment, Inc. • **Philadelphia**—Philadelphia Blue Print Co. • **Pittsburgh**—American Blue Printing Co. • **Portland**—The J. K. Gill Co. • **St. Louis**—Service Blue Print & Photo Copy Co. • **Seattle**—Kuker-Ranken, Inc. • **Toledo**—Toledo Blue Print & Paper Co. • **Tulsa**—Triangle Blue Print & Supply Co.

also available through Post dealers
in other principal cities

INSTRUMENTS, EQUIPMENT AND MATERIALS FOR THE ENGINEER AND ARCHITECT. BLUE PRINT PAPERS AND KINDRED SENSITIZED PRODUCTS.



Generating Modulated Micro-Waves

DR. VICTOR A. BABITS
University of Technical Sciences, Budapest.

THE DIFFICULTIES experienced in connection with the modulation of existing micro-wave oscillators are well known. In the following a micro-wave oscillator is described in which the mentioned difficulties have been eliminated. In principle, the device consists of two parts: the micro-wave oscillator, and the modulator. The micro-wave oscilla-

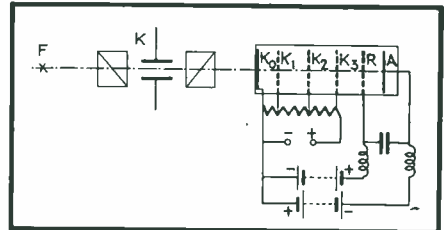

Fig. 1. — Modulated electron-multiplier and microwave generator

tor is, but for one important alteration, similar to any of the usual electron multipliers.

In Fig. 1 an electron multiplier device with emitting cathode K_0 , and multiplying cathodes K_1 , K_2 , K_3 is shown. In the new device a grid R and an anode A are added.

The grid R receives a higher voltage than K_3 as compared with the cathode K_0 , and the anode A a high negative potential against K_0 . The electrons

DANISH ATOM SPLITTER

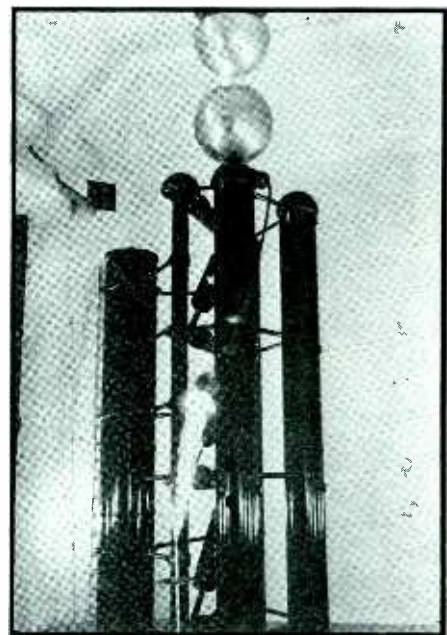

Dr. Nils Bohr, famous originator of the "solar system" atom, has at his disposal a new atomic research laboratory, the high voltage generator of which is shown above

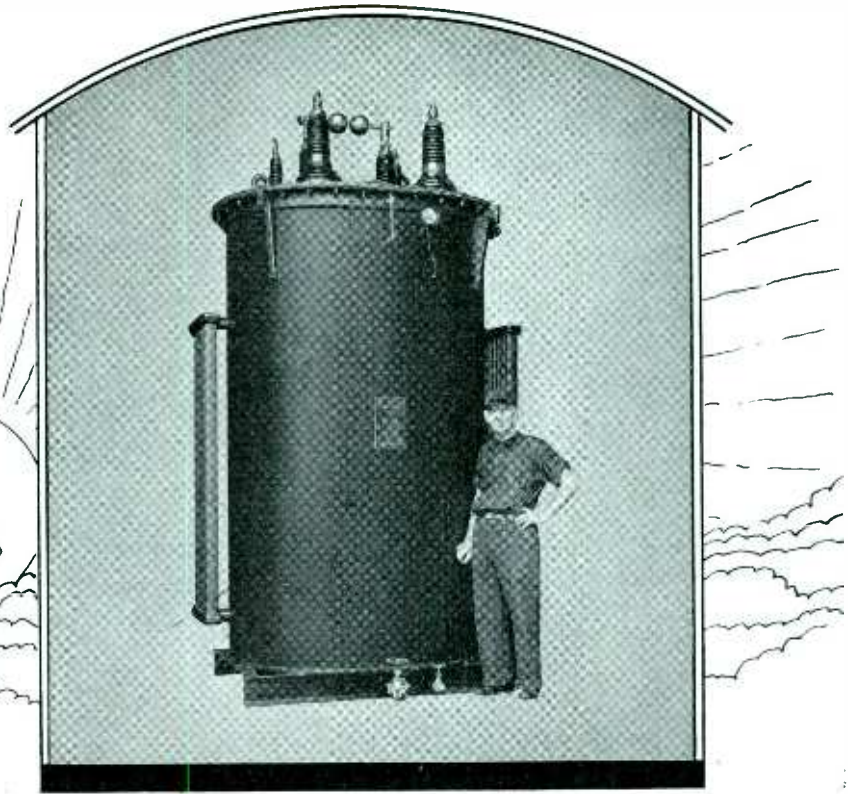
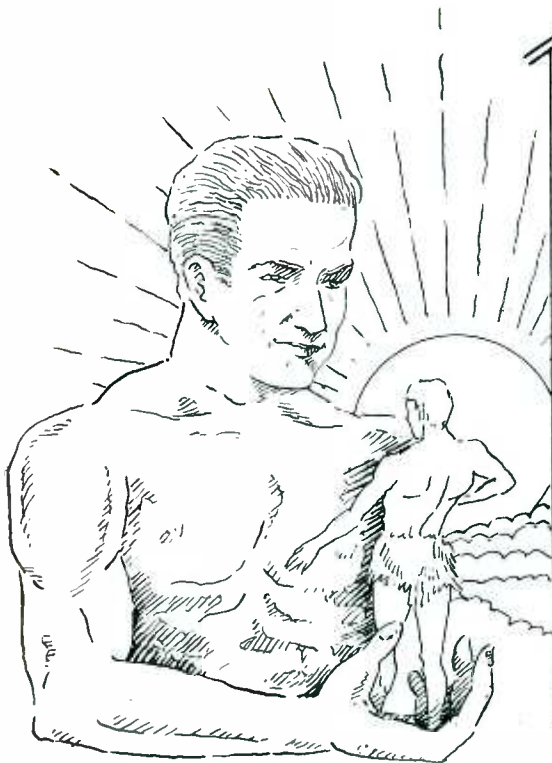

Transformers for Every Electronic Application



All sizes of AmerTran Audio Transformers from the 3-ounce "Midget" air-craft unit (above) to the 12-ton modulation transformer (upper right) offer the same excellent operating characteristics and electrical efficiency.



AmerTran Transformers are also available in all intermediate sizes and for all electronic applications. Shown above is a standard design of air-insulated plate transformer for a small broadcast transmitter.

THE term "from Midgets to Giants" is hardly applicable when discussing AmerTran Transformers for Electronic Applications, so great is the range of ratings of available equipment. Twenty years before the introduction of broadcasting (since 1901) our company became associated with the radio industry by supplying transformers for many of the earliest wireless stations. Since that time we have furnished every conceivable type of transformer equipment for use in radio and electronic circuits—from the smallest audio units used in air-craft receivers to large power and modulation transformers required in 500 Kw. transmitters. To-day AmerTran Transformers are considered throughout the world as "The Standard of Excellence" for all electronic applications. For additional data visit our booth at the I.R.E. Convention, Hotel Pennsylvania, N. Y. C., June 16 to 18.

AMERICAN TRANSFORMER COMPANY

178 Emmet St.,



Newark, N. J.

AMERTRAN

That the Fairchild Portable Recorder is the outstanding instrument in its field is not news —but, that it's been improved, IS!

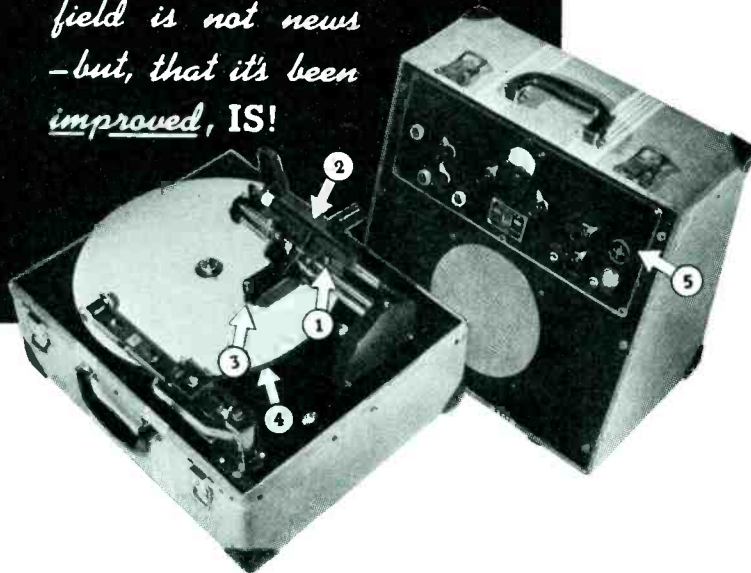

This is the Model F-26-2 Recorder, bringing even finer quality to the finished recording through the incorporation of many new features in both recorder and amplifier:

1. RECORDER HEAD CARRIAGE MECHANISM—assures absolute freedom of movement vertically, with no movement horizontally, by ground cone ball-bearings supporting the cutter head arm.
2. RECORDING SCALE—a new scale reading direct in minutes for all pitches and both OUT-IN and IN-OUT.
3. CRYSTAL CUTTER HEAD—a completely new design incorporating improvements in the

advance ball and its method of adjustment.

4. MOTORDRIVE—at $33\frac{1}{3}$ r.p.m., split-second timing is achieved by direct synchronous speed gear and worm drive. The playback of a program always coincides to the second with the original program's length.

5. RECORDING AMPLIFIER—re-designed for ease of operation with an inclined front panel and all controls conveniently grouped at the top.

The Model F-26-2 Recorder in its light, smart and sturdy new carrying-case, has been brought to a new pitch of perfection in both appearance and performance.

For full information, send for descriptive literature.

"... it had to satisfy Fairchild  first"

FAIRCHILD
Sound Equipment Division

AERIAL CAMERA CORPORATION
88-06 Van Wyck Boulevard, Jamaica, L. I., N. Y.

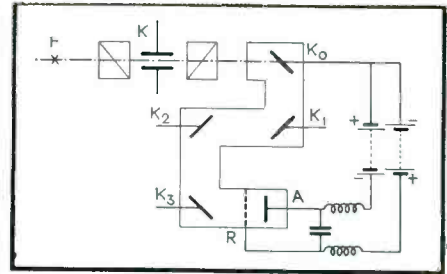

Fig. 2. — Use of modulation system with reflection-type multiplier

flowing from K_3 toward R will then vibrate as in the Barkhausen-Kurz oscillator, and the frequency of these oscillations will depend on the grid voltage R and the anode voltages A applied.

The number of electrons emitted by K_3 toward R depends on the multiplying factor of the electron multiplier and on the quantity of light falling on K_0 . In the case of the device with the Kerr cell K , for instance, the quantity of light falling onto K_0 from the light source F can be varied according to the modulating voltage. In cases where the so-called dark current of the electron multiplier can be practically neglected, modulation can be increased to hundred per cent.

Fig. 2 shows a device working on a similar principle, but with another kind of electron multiplier. Modulation of the light falling onto K_0 can be carried through by electrical, magnetic or mechanical means.

WATER-LEVEL INDICATOR

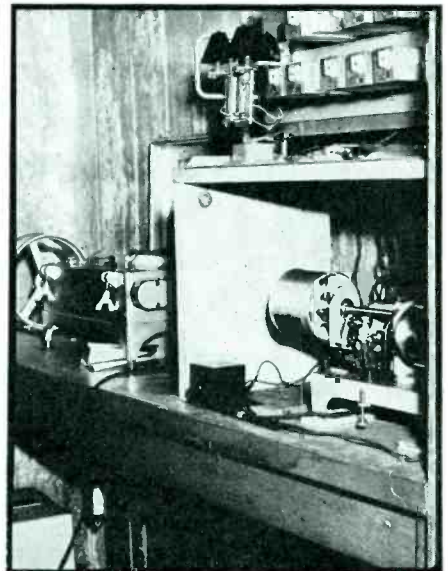

An automatic indicator for keeping tabs on the water level of the Potomac River has recently been installed by the U. S. Weather Bureau. The apparatus makes a permanent record of the water-level variations, and will indicate the level telephonically, whenever a call is put through to the apparatus

RELAYS THAT "Click" IN MODERN CONTROL CIRCUITS

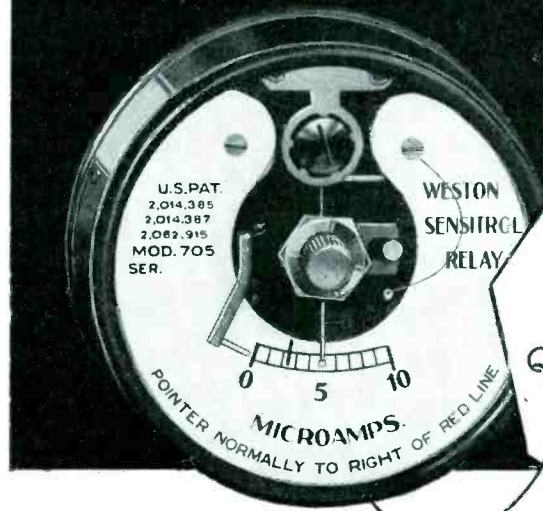

WESTON Model 705 Sensitrol Relays

Operate from thermocouples, resistance thermometers, photocells and electronic circuits . . . provide positive control at energy levels as low as 1 millivolt or 2 microamperes . . . handle 50 milliamperes at 110 volts on contacts . . . made in hand reset and solenoid reset types.

No matter how limited the energy available—down to a bare 2 microamperes—WESTON Sensitrol Relays, with indicating scales, can put it to work as a means of positive control. Similarly, if operating speed, high output or some other critical element is the limiting factor, there are other WESTON Relays which meet each requirement "on the nose."

Today, as engineers and industrial executives make plans for safer, surer and more flexible means of electrified control, they design their circuits around the positive, unfailing contacts of WESTON Relays. One or more of these units is almost certain to meet your own specific needs. Why not write for a copy of "WESTON Relays"—a 12-page bulletin giving full specifications? Weston Electrical Instrument Corp., 618 Frelinghuysen Ave., Newark, N. J.



Time Delay Relays (Model 613)

Compensated bi metal operation . . . single or double circuit . . . provides time delay of 15 sec. to 1 minute between initial impulse and operation . . . handles up to 25 watts at 110-volts output.



Sensitive Relays (Model 30)

Permanent magnet, movable coil operation . . . for circuits up to 200 milliamperes, 6 volts, DC . . . in types for "high-low" voltage (or current) control, and for regulation of voltage (or current) within 1%. Also "microampere" type, operating from high-side to low-side at a minimum differential of 15 microamperes.



Sensitive Indicating Relays (Model 730)

Designed specifically for alarm circuit use where current is normally held at 2 milliamperes . . . standard model serves as indicator over 0-4 milliamperere range, with contacts at 1 and 3 milliamperes . . . compact and inexpensive.

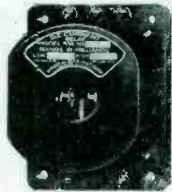

Sensitive Relays (Model 534)

Compact, permanent magnet, movable coil operation . . . for circuits up to 200 milliamperes, 6 volts, DC . . . for surface or flush mounting in current relay, voltage relay or "microampere" types.



Power Relays (Model 630)

Electro-magnetic type with one to four mercury switch contacts . . . designed particularly for use with sensitive relays to supply output energy up to 1000 watts . . . operate on 6 volts DC, or from transformer rectifier unit.

WESTON Instruments

RESISTORS

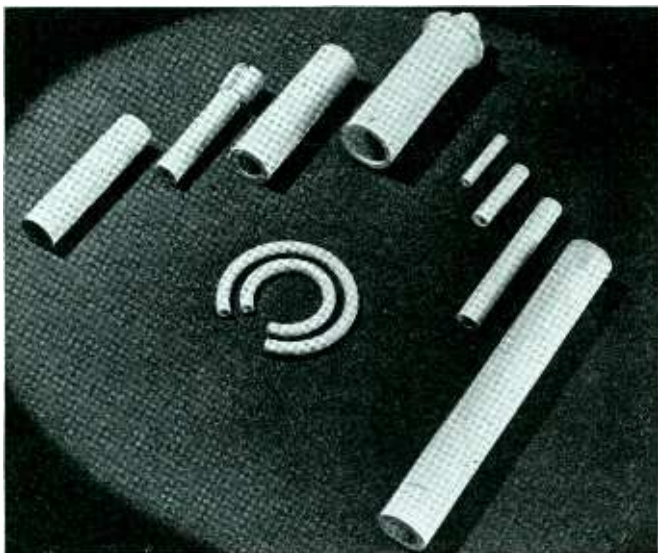

WHY WE MAKE OUR OWN REFRACTORIES



A wire wound resistor is only comprised of three elements . . . the refractory, the wire and the enamel. Each must expand and contract in relation to the other two in order that changes of temperature do not cause damage. By careful selection of the basic materials and the controlled production of the resistor refractories, Ward Leonard is enabled to match refractories to both wire and enamel thus giving Ward Leonard Resistors the long life that has always characterized them.

BULLETIN 11 tells about Vitrohm Wire Wound Resistors, gives sizes, watt ratings.

BULLETIN 19 describes Ward Leonard Ribflex Resistors for unusually heavy duties.

BULLETIN 25 is a treatise of standard and special mountings and enclosures.

WARD LEONARD

RELAYS • RESISTORS • RHEOSTATS

Electric control  devices since 1892

Ward Leonard Electric Company, 32 South Street, Mount Vernon, N. Y.

Please send me Bulletins No.

Name

Firm.

Address

City State

A Sound Effects Machine With High Impedance Mixing

M. J. WEINER
Chief Engineer, WNEW.

AN IMPORTANT PHASE in the broadcasting of dramatic programs is the recorded production of incidental sound effects, of which there are an almost endless variety. In order to produce the various sounds required in rapid sequence, a minimum of three turntables is required. Certain shows require the playing of sound effects records, on all three turntables simultaneously, in addition to the use of a so-called "filter microphone", the latter being used to simulate telephone conversations.

Experience with an older machine, using heavy magnetic pick-ups with inertia tone arms, showed excessive wear and poor tracking, particularly on the instantaneous ("acetate") type recordings. Due to the poor tracking, a slight jarring of the machine, would skid the needle point across the record, making it unfit for further use.

It was found that the use of a light crystal pickup completely eliminated these difficulties, and permitted a great many more playings of a given record. Good tracking was also obtained on the acetate type pressings.

The design of a new machine therefore called for three crystal pickups and the filter microphone, working into a four position mixer. Four pre-amplifiers would ordinarily be required, but

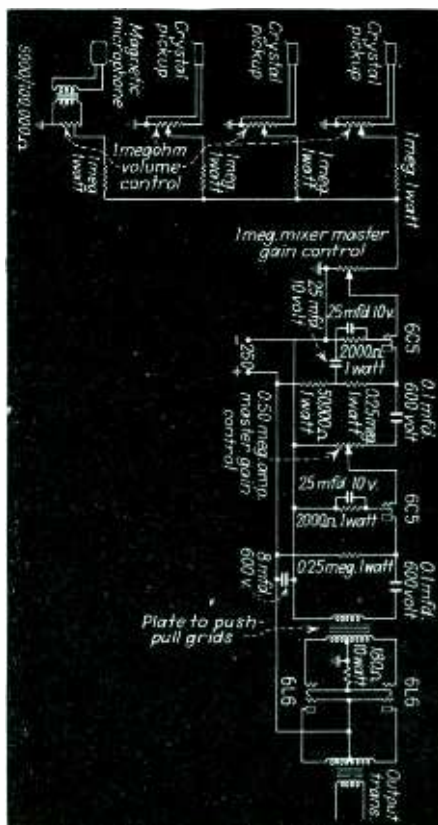
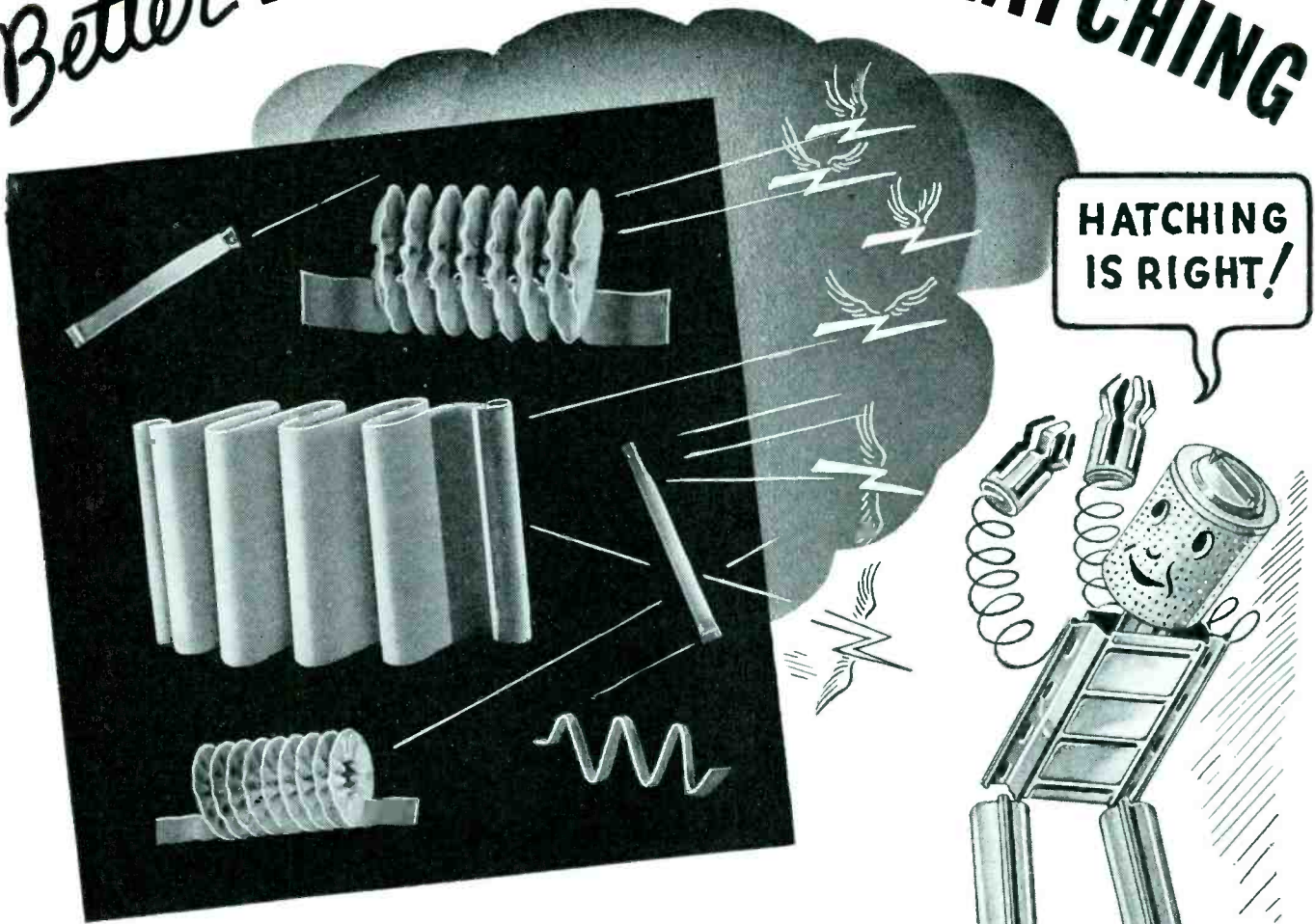

Diagram of four-position mixer and amplifier used for sound effects. High impedance crystal pick-ups are used.

Better INCUBATORS More HATCHING



Nickel cathodes hatch electrons with greater ease... over a longer period of time

SPEEDING ELECTRONS...as essential to radio amplification as chicks to a poultry farm...have to be hatched, too. And again, this time in the hatching of electrons, Nickel performs for radio an important, life-giving service: Here's the way of it:

When the cathode is heated (by the heater filament) electrons are hatched from the active coating covering the metal. And because Nickel is compatible with the active coating used on cathodes, it hatches electrons more easily and quickly, and keeps right on...longer than any other metal.

On the ease and certainty with which electrons can be generated depends the efficiency of the mod-

ern amplifying tube.

Thus, Nickel makes quicker acting, more efficient tubes that deliver more dependable performance, longer life. That is why radio engineers, after countless tests through over 30 years of radio development use Nickel for cathodes, in preference to any other metal.

In many other radio and electrical applications, too, Nickel and Nickel alloys are daily answering long-felt wants. So in selecting metals consider Nickel...its unique combination of properties may give you just what you seek. For technical information and your copy of "Nickel in the Radio Industry" write "Electrical Research," c/o

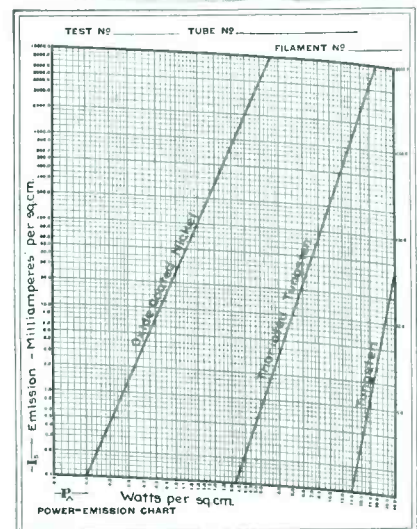

NICKEL

THE INTERNATIONAL NICKEL COMPANY, INC., 67 WALL ST., NEW YORK, N. Y.

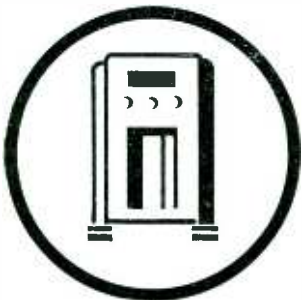

R
for all
1939 models



**THE NEW
IMPROVED 1100 SERIES
GOAT FORM FITTING
TUBE SHIELD**

There is a Goat form-fitting tube shield for every type of radio receiver . . . Auto, Battery, AC-DC, A-C, phono-combination, communication receivers, etc. Goat Tube Shields have been designed in close cooperation with the country's leading tube engineers.

Send for Bulletin TS-5, samples and prices.

features

- | | |
|---------------------|--------------------|
| Sturdy Construction | Magnetic Shielding |
| Greater Stability | Easy Assembly |
| Improved Grounding | Space Saving |
| Complete Shielding | Beaded Top |
| Better Appearance | Economy |

GOAT RADIO TUBE PARTS, INC.

314 DEAN ST., BROOKLYN, N. Y.

(A DIVISION OF THE FRED GOAT CO., EST. 1893)



would result in a set-up too cumbersome for portable work, especially since the machine was to be put into the hands of non-technical people. The pre-amplifiers were accordingly discarded in favor of direct mixing.

The figure shows the arrangement which was finally evolved. It is a simple parallel mixer using inexpensive receiver type audio volume controls. The series compensating resistors completely eliminate all trace of interaction between mixer controls. While these compensating resistors do cause a loss in level, the amplifier following the mixer has sufficient gain to drive the 6L6 output tubes to full capacity.

In addition to the mixer master gain control, a main gain control is provided on the amplifier chassis. The amplifier itself is placed inside the cabinet of the sound effects machine, and its volume control set, so that the operation of the mixer wide open, will not result in damage to the output circuit and loud speakers.

The mixer output, being high impedance, can be connected directly to the grid of the first amplifier stage, instead of being connected through the usual step-up transformer, thereby eliminating any hum pick-up from this source. The mixer circuits should be wired with low capacity shielded cable. Proper wiring will result in completely noiseless, hum-free operation.

The frequency characteristic of the crystal pick-ups can be varied to suit the individual installation, by placing shunt resistors across the controls.

The filter microphone is an RCA magnetic type, and its output characteristic is such that it sounds like an ordinary telephone. No additional audio filtering is required to simulate telephone conversations.

The measured gain of the amplifier at 1000 cycles, is 80 db., while its frequency characteristic is flat within 2 db., from 30 to 10,000 cycles. Two dynamic speakers with their associated field supplies are mounted inside the cabinet of the machine. Two speakers were used because of the relatively high output power available from the amplifier. As a further refinement, an acoustic labyrinth consisting of one inch celotex sheets was installed, resulting in a considerable improvement in quality. Due to the limited space available in the cabinet, the labyrinth was smaller in size than the optimum value required. The extra effort and expense required for its installation, was really worth while, however, since it eliminated most of the resonance due to the cabinet itself.

As a further aid to coordination between the studio control engineer and the sound effects operator, the output of the studio amplifier is fed back to a jack on the mixer panel of the sound effects machine. A pair of telephone receivers plugged into this jack, permits the sound effects operator to listen to the balance established between the actor's microphones and the background microphone, which is used to pick up the sound effects.

Centralab FIXED RESISTOR

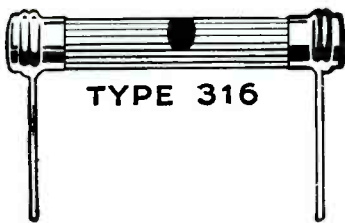

TYPE 316

Baptized in fire at 2500 degrees . . . hard as stone. Center core and ceramic jacket fired together to form a single shock-proof unit. Pure copper covers resistor end for wire lead contact.

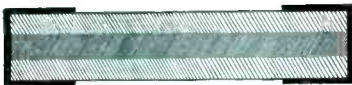

X-Ray sketch showing the conductor and dense ceramic jacket all in one piece — providing exceptional strength and protection against humidity. Uniform resistance and load distribution over entire length.

Center-Lead RESISTOR

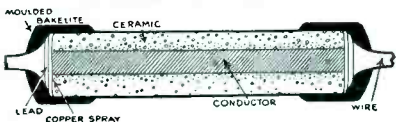

Centralab's newest Resistor advancement! Same ceramic covering—same solid center resistance material . . . now available in Center-Lead form for insulation and added convenience.

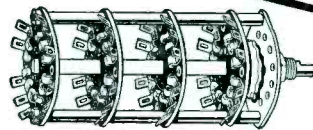

The New Centralab SELECTOR SWITCH

Now, infinite switching combinations are available at your jobbers in the new Centralab Switch Kits. Made in Isolantite or Bakelite. Also built to specifications for set builders.

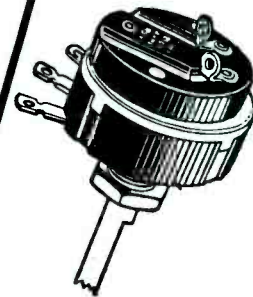

Centralab RADIOHM

Millions in use as original equipment and as replacements . . . uses the famous smooth non-rubbing contact for noiseless attenuation. Available in various combinations.

Centralab
CENTRAL RADIO  LABORATORIES

at the
**NATIONAL RADIO
PARTS TRADE SHOW**

Old Man Centralab, that fine symbol of Service and satisfaction, was much in evidence at 114-116 Bell Street in Radio Parts City at the 1938 show. Manufacturers, experimenters and service men, to say nothing of the ever-present ham, were making the rounds gleaning information from a hundred sources.

We sincerely hope you were able to "make it."

**STEVENS HOTEL
Chicago
June 8th to 11th**

CENTRALAB: Div. of Globe-Union Inc., Milwaukee, Wis.



In the Air *** and on the Ground it's OHMITE with BENDIX

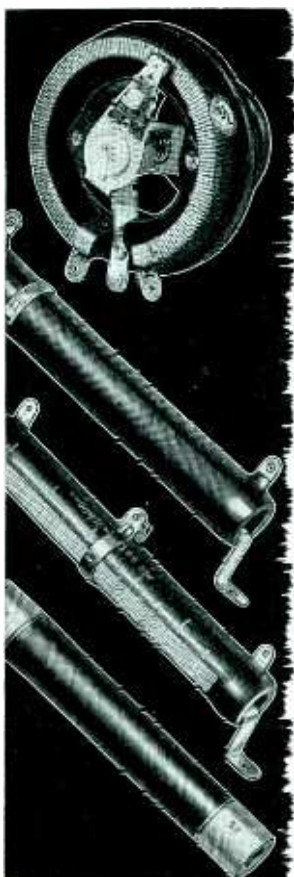

Ohmite Vitreous-Enamelled Resistors and Rheostats are Standard Equipment in Bendix Plane and Ground-Station Transmitters.

★ Nowhere, of course, is there greater emphasis upon reliability, greater insistence on generous safety factors, than in aviation—especially aviation communications. In all kinds of weather, under the most severe operating conditions, each component part must perform unflinchingly. Shown above are two of the modern plane and ground-station transmitters built by the Bendix Radio Corporation and used in domestic and foreign commercial and governmental air services. Ohmite Vitreous-Enamelled Resistors and Rheostats are standard in Bendix radio equipment because Bendix knows it can rely on Ohmite dependability. Let Ohmite Engineers analyze your resistance problems and submit samples to meet your exact requirements.

Write for Your Copy of New Catalog 17.

★ Ohmite Vitreous Enamel is unexcelled as a protective and bonding covering for resistors and rheostats.

OHMITE

RESISTORS RHEOSTATS SWITCHES

OHMITE MANUFACTURING COMPANY
4825 W. Flournoy Ave. Chicago, U.S.A.

Modulation Depth Measuring Instrument

IN THE MARCH issue of the *Philips Set-makers' Bulletin*, a publication of Philips Gloeilampenfabriken, Eindhoven, Holland, is an article on "The Tuning Indicator as a Modulation Depth Measuring Instrument," from which the following information is taken.

In many cases it is necessary to determine the modulation depth of the measuring signal of a signal generator. The most suitable auxiliary means of doing this is by the use of a cathode ray oscillograph on which the modulation depth can be read immediately in the form of an oscillogram.

Other, and in some cases, less complicated methods are also available. Fig. 1 shows a diode with a circuit tuned to the signal to be examined.

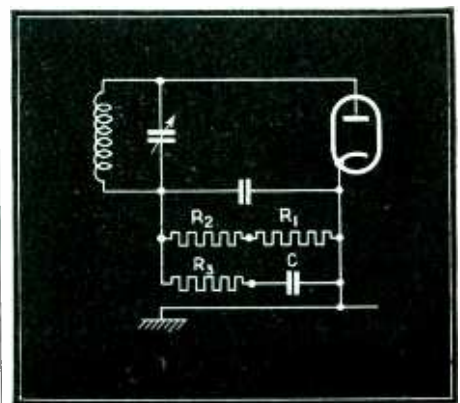

Fig. 1—Diode rectifier and tuned input circuit. The rectified signal is produced across R_1 and 2^2

The rectified signal is produced across the resistors R_2 and R_1 in series. The wave form of the rectified signal is given in Fig. 2, in which the alternating component is superimposed upon the direct or steady component. If the

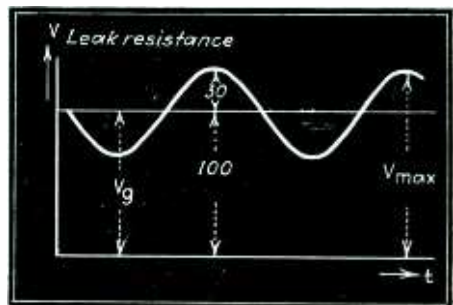

Fig. 2—Wave form of rectified signal with 30% modulation

modulation depth is 30% the modulation voltage will be 30% of the steady voltage, provided the signal is sufficiently large to insure linear detector operation.

For determining the depth of modulation, the a-c and d-c components of the rectified signal voltage would have to be compared with one another. For this purpose the modulation voltage is filtered out with the filter R_3C in Fig. 1 so that only the direct voltage, V_g , remains at C .

First Use of Radio: Communications. First in Radio Communications: RCA



First RCA Experimental Laboratory at Riverhead, Long Island—1919

THE Radio Age began with radio communications. Practically all present day developments of radio, not only in broadcasting, but in every other direction, have grown out of communications research.

Each advance in one branch of radio knowledge has contributed to the progress of other branches. Broadcasting, because of its widespread appeal, has been the most conspicuous radio service for a number of years, yet its success has not caused any lessening in the advance of older

radio services, marine and international communications.

From its very beginning, RCA has been a research organization. The men who organized this company, and have since conducted it, have always been fully aware of the necessity for unceasing exploration in the vast field opened up by radio's pioneers.

The radio research which RCA has sponsored within a period of nearly 20 years is the foundation for the many ways in which RCA serves millions of people.

Listen to the Magic Key of RCA, presented every Sunday, 2 to 3 p. m., E. D. S. T. over NBC Blue Network



Radio Corporation of America

RADIO CITY, N. Y.

RCA Manufacturing Co., Inc.—Radiomarine Corporation of America—RCA Institutes, Inc.
National Broadcasting Company—RCA Communications, Inc.

THE

★ New, Complete

LINE OF RADIOTONE RECORDERS

For more than four years, RADIOTONE RECORDERS have been favorites in the critical Hollywood market in which they are manufactured. Now, with manufacturing facilities increased and a new, complete line in production, RADIOTONE RECORDERS are offered to users everywhere. Here we picture and briefly describe four professional models—each one the leader in its field. Other models, for home use, are sold through progressive dealers. And custom-built models are manufactured by RADIOTONE to solve difficult problems. No matter what you demand in a Recorder, RADIOTONE offers you the most practical, most economical solution!

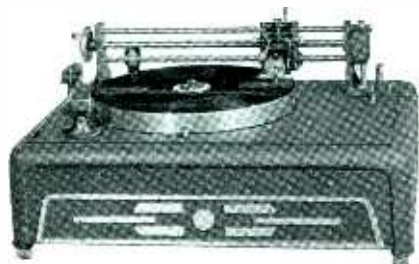

PR-20 STUDIO MODEL (above) Instantaneous change from 33-1/2 to 78 RPM, instantaneous change from inside-out to outside-in cutting; variable lines-per-inch from 90 to 125; Line-spreader and Microscope—everything you may want in one compact model. Overhead lathe-type lead screw offers perfect grooving; all cutting-head adjustments rapidly and accurately made. Very heavy, vibration-free construction. Synchronous, self-starting motor, operating through a live-rubber rim drive. Balanced, especially-designed playback arm. The RADIOTONE PR-20 offers you everything in a 16" Acetate Recorder.

PR-16 PORTABLE TYPE (below) All of the features of the PR-20, plus portability. Vibrationless operation is secured by the unique drive, motor mounted in live rubber, and cast aluminum panel. RADIOTONE PR-16 is capable of producing the finest instantaneous or processing records, yet is easily carried from one place to another.

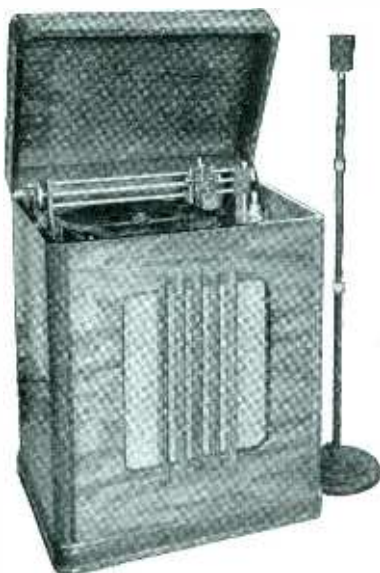

PR-50 CONSOLE TYPE (left) For use in offices, auditoriums, or studios where appearance is important, the RADIOTONE PR-50 Console is ideal! Complete with matching, built-in Amplifier, this Recorder has all of the features of the PR-20 and PR-16, combined in a massive matched walnut cabinet of beautiful modern design. Built-in Radio Tuner if desired.

PR-12 PORTABLE RECORDER (below) For sure-fire results in a portable Recorder, RADIOTONE PR-12 offers everything. 12", 78 RPM Turntable, quick change from inside-out to outside-in, 96 lines per inch (others can be furnished if desired), perfected lathe-type lead screw. Easy to carry, and easy and sure to use. Very moderately priced.

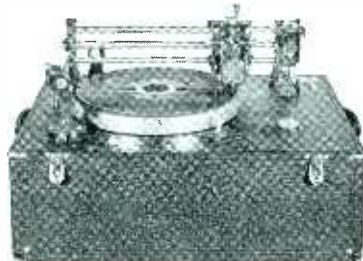

Write for full Information and Specifications or See These Models at the RMA Show, June 7 to 11

DEALERS: Radiotone Recorders are also made in a line of Home Models, sold on a clean-cut Dealer Policy. Write for information!

Radiotone Inc. MANUFACTURERS

6101 Melrose Ave., Hollywood, Calif. • 620 N. Michigan, Chicago, Ill.

The maximum voltage, V_{max} , across R_1R_2 is $1.3V_g$ for 30% modulation. If R_1 is now taken equal to $(R_1 + R_2)/1.3$, then the greatest voltage across R_1 is V_g . Once the ratio R_1/R_2 has been established in this manner, it is known that, independently of the signal strength at a modulation depth of less than 30%, the negative voltage at R_1 cannot exceed that at C under any conditions.

To adjust the signal generator to a value of 30%, the modulation depth must be increased from zero until the peak voltage at R_1 just begins to exceed that at C . It is still necessary to find a means of indicating when this value is exceeded. For this purpose a diode can be inserted in the circuit as shown in Fig. 3. When the prescribed modulation depth is exceeded, the diode

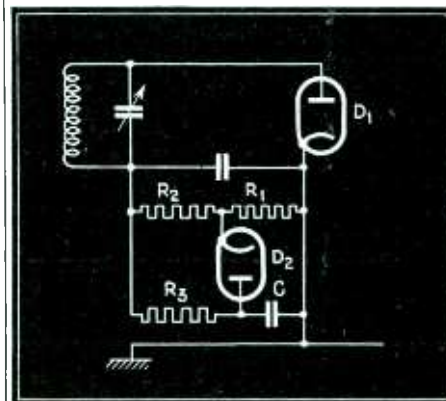

Fig. 3—A second diode, D_2 , becomes conductive when the modulation exceeds a certain prescribed value

cathode may become more negative than the anode. The diode then becomes conductive. The voltage at C varies negatively since current flows through the diode. The increase in the negative voltage at C is easily established by using this voltage to control a tuning indicator, EM 1. The complete circuit is shown in Fig. 4.

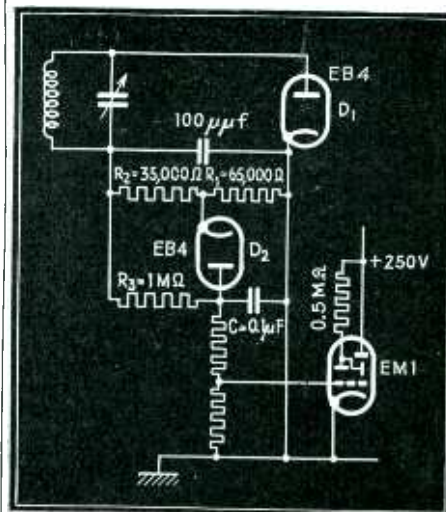

Fig. 4—Complete circuit for measuring depth of modulation. The tubes specified are European, but the American types would be equally suitable



TINY ONLY IN SIZE

Manufacturers of radio receiving sets and of other electronic equipment know that even the smallest insulated resistor they use must help sustain their reputation. They know that failure of any part, no matter how small, can undo the work of years.

They know, too, the reliance they place on SPEER Insulated Resistors. It explains the ever growing use of these correctly designed, carefully constructed, rigidly tested products of the 40-year-old SPEER organization of carbon products specialists.

SPEER Insulated Resistors — carbon resistance elements with copper sprayed ends drive-fitted to tinned copper leads and hermetically sealed in Bakelite shells and color coded to R.M.A. standards, provide accurate ratings, uniformity, immunity to destructive influences encountered in normal service anywhere in the world. Samples and quotations supplied to manufacturers on request. SPEER wire-wound insulated resistors are also available in all resistance values and several sizes.

SPEER CARBON CO., ST. MARYS, PA.

| | | |
|-----------|-----------|------------|
| Chicago | Cleveland | Detroit |
| Milwaukee | New York | Pittsburgh |

SPEER INSULATED RESISTORS

STABLE-



The New
ERIE
Silver Mica
Condensers

*As Constant as
the North Star*

HERE is a new Eric Condenser for the radio field that's a star for stability. These units are practically constant in capacity regardless of changes in temperature, humidity and length of use.

They consist of pure silver plates in intimate contact with mica dielectric and sealed in a low-loss ceramic case. Eric Silver Mica Condensers are specifically designed for use in tuned oscillator circuits in which the L x C product must not change regardless of operating conditions. The Type F unit has a positive temperature coefficient of only .000025 mmf/mmf/°C. For the midget Type A condenser it is but +.00004 mmf/mmf/°C. This midget Type A unit is ideal for installations such as inside I.F. shield cans where there is a premium on space.

Eric Silver Mica Condensers have been in development for over a year. Announcement has been withheld until their superior performance and dependability has been definitely assured by thorough tests. Both sizes of these remarkable condensers are available now in production quantities. Their characteristics are outlined below:

- 1 **CONSTRUCTION:** Mica dielectric with pure silver plates in intimate contact.
- 2 **SIZE:** Type F, $\frac{5}{8}$ " x $1\frac{1}{4}$ " long x $\frac{1}{8}$ " thick. Midget Type A, $\frac{1}{2}$ " x $\frac{3}{4}$ " x $\frac{1}{2}$ " thick.
- 3 **TEMPERATURE COEFFICIENT:** Type F, +.000025 mmf/mmf/°C. Type A, +.00004 mmf/mmf/°C.
- 4 **POWER FACTOR:** Less than .04%.
- 5 **LIFE:** Less than 0.1% change in capacity after 1,000 hours of alternate cycles at 40°F. and 175°F.
- 6 **HUMIDITY:** Sealed in low loss ceramic case with special waxes. Change in capacity less than 0.1%, power factor less than .05% and leakage resistance greater than 1,000 megohms



- after 100 hours at 100% humidity and 40° C.
- 7 **TOLERANCE:** Furnished in ±1%, ±2%, ±3%, ±5%, ±10% of stated capacity. Minimum Tolerance ±.25 mmf.
- 8 **VOLTAGE:** Tested at 1,300 volts, 60 cycle A.C. Rated at 500 volts D.C.
- 9 **RANGE:** Type F, 15 mmf.—2500 mmf. Midget Type A, 40 mmf.—120 mmf.

ERIE RESISTOR CORPORATION, Erie, Pa.

TORONTO, CANADA • LONDON, ENGLAND • PARIS, FRANCE-J.E.CANETTI CO.

RESISTORS • SUPPRESSORS • CERAMIC CONDENSERS • INJECTION MOLDED PLASTICS

The measuring circuit is coupled to the oscillator circuit of the signal generator in such a manner that the visible tuning indicator shows a certain deflection. The modulation can then be increased until the tuning indicator shows an increasing deflection. With a voltage divider connected in parallel with C, the ratio $R_1/(R_1 + R_2)$ must be slightly modified. The voltage at C actually becomes equal to $6V_g/7$. A deflection at 30% modulation depth is obtained when $1.3V_gR_1/(R_1 + R_2) = 6V_g/7$. Therefore, $R_1/(R_1 + R_2) = 6/(1.3 \times 7) = 0.65$. Thus, for example, we may make $R_1 = 65,000$ ohms and $R_2 = 35,000$ ohms. For adjustment to other values of modulation depth, the values of the resistances must be calculated accordingly.

Study of Space Charge Effects in Electron Tubes

TWO EXTENSIVE PAPERS dealing with space charge effects in electron tubes have been published recently. One of these is "Effects of Space Charge in the Grid-Anode Region of the Vacuum Tube" by Bernard Salzberg and A. V. Haeff, appearing in the January issue of the *RCA Review*. The other is "On the Theory of Space Charge Between Parallel Plane Electrodes" by C. E. Fay, A. L. Samuel and W. Shockley, in the January, 1938, issue of the *Bell System Technical Journal*.

The paper by Salzberg and Haeff deals with the effects of space charge in the region between grid and anode of a vacuum tube, for the case where the planes of grid and plate are parallel. The main effects of the space charge are: (a) to introduce departures from the linear potential distribution of the electrostatic case; (b) to set an upper limit, under certain conditions, for the anode current; (c) to introduce instability and hysteresis phenomena in the behavior of the tube; and (d) to increase the electron transit time in this region. Four modes of potential distribution which may exist in this region are treated. The voltage-current curve representing observations made on specially constructed tetrodes are given by way of experimental verification of the theoretical results.

The article in the *B.S.T.J.* deals with the problem of the potential distribution, current, and electron transit time resulting from the perpendicular injection of electrons into the space between parallel planes. The electrons are assumed to be injected uniformly with velocities corresponding to the potential of the planes to which they are injected. Consideration of all possible solutions of the basic equation shows that four general types of potential distribution are possible. Curves are given which enables the calculation of transmitted current and transit time and show the complete potential distribution for any concrete example. The case for current injected to both planes is also considered. A complete mathematical treatment is given in the appendix.

•
1938

MANAGEMENT OBJECTIVES

Stimulate Salesmen!

THEY NEED IT!

They have heard so much about business curves—about government regulation and interference with business—about taxes—*that many of them are waiting for conditions to improve.*

You can't afford to have your salesmen wait. They need to sell harder on every call. It's your job to give them new courage and inspiration.

There is nothing so encouraging—so inspiring—to salesmen, as a greater, more dramatic advertising program. This is an important plus value to the sales-increasing cost-reducing power of advertising. It proves *your* sincerity and helpfulness.

Ask your advertising agency whether your appropriation is adequate to accomplish this objective.

Published in the interests of greater sales, employment and profits in 1938 by the
MCGRAW-HILL PUBLISHING COMPANY, INC., NEW YORK, N. Y.

RELAYS

FOR ANY INDUSTRIAL REQUIREMENT—

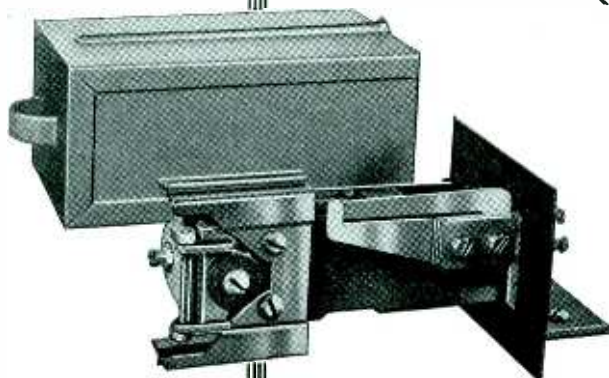

• Series AQA Relay equipped with Mounting Bracket, Cover Guide, and Cover. A standard model for general uses where requirements call for rapid switching of one or more circuits.

• The Automatic Electric line of relays includes quick and delayed action types, sensitive and heavy duty types, mechanical locking types, polarized relays, etc. Available with any contact combination and for operation on D.C. or A.C. circuits of any voltage.

Write for complete illustrated catalog of relays, stepping switches, electric counters, solenoids, keys, and other electrical control accessories. Address American Automatic Electric Sales Company, 1033 W. Van Buren St.,

AUTOMATIC  ELECTRIC

MAKERS OF TELEPHONE AND SIGNALING APPARATUS
ELECTRICAL ENGINEERS, DESIGNERS AND CONSULTANTS

BE AMONG THE LEADERS— USE ALLIED "CLEEN CUT" BLANKS

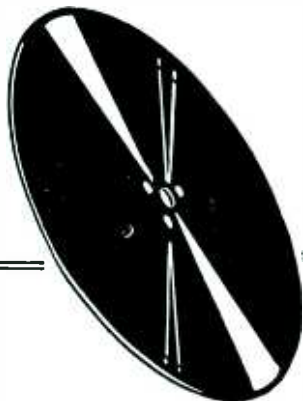

- . . . cut easier.
- . . . have less surface noise.
- . . . wear longer.
- . . . are perfectly flat.
- . . . styli last longer.
- . . . thread is not statically charged.
- . . . assure better results.
- . . . make recording work a pleasure.
- . . . cost no more.

**ALLIED RECORDING
PRODUCTS COMPANY**

126 W. 46th St.
New York City

Cable Address: Allrecord

Phone: Bryant 9-1435

Capacitance of a Diode

IN THE MARCH issue of the *Proceedings of the Wireless Section*, published by the Institution of Electrical Engineers in London, E. B. Moullin discusses "The Apparent Inter-electrode Capacitance of a Planar Diode."

Various experiments have suggested that the effective capacitance of a diode is probably dependent on the magnitude of the plate current. This effect, however, is not disclosed by the classic analyses of Benham or of Llewellyn. Moullin's paper shows that an analysis which ignores the emission velocity of electrons is not competent to describe the capacitance effect in a diode. A steady-state solution is found for a planar diode in which the emission velocity is not ignored. Also, it is calculated that the mean-square velocity of electrons crossing the potential barrier is the same as the mean square velocity of emission from the cathode. By considering the inertia effect of the electrons in conjunction with the displacement current at the barrier, an expression is derived for the phase angle of an electrode system. This expression shows that the phase angle is markedly dependent on the plate current.

An appendix contains the steady-state solution of the temperature-saturated planar diode, and curves are given which show the force at the cathode and at the plate as a function of the plate current, expressed as a fraction of the space charge limited current. A curve which shows the transit time as a function of the plate current is also given.

• • •

FACSIMILE TRANSMITTING EQUIPMENT



Equipment for producing facsimile signals, suitable for modulating any broadcast transmitter, was demonstrated by RCA at the Philadelphia Electrical Show

Cathode Ray Tube Applications

SOMEWHAT IN THE NATURE of "Stealing our thunder," *Instruments*, "the magazine of measurement and control," gives an extensive list of applications of cathode ray tubes in its March issue.

The list is prepared by Ralph R. Batcher who has written a long series of articles for *Instruments* on the various aspects of cathode ray oscillography. From the fields of acoustics to television, 179 references are given on various applications of cathode ray oscillography. We begin to suspect that cathode ray tubes may be put to as many uses as the versatile phototube which has caught public fancy under the alias, "electric eye."

The Radio Industry— A Survey

THE RADIO INDUSTRY has its inning in the May issue of *Fortune*. Staff articles on "Radio Broadcasting," "Radio Talent," and "Radio Sets" are separate articles dealing with three aspects of the radio industry. In addition to this, an article on the Federal Communications Commission is part of a symposium on business and government.

In these series of articles the radio industry is thoroughly aired in the usual pungent, take-it-or-leave-it style of *Fortune*.

• • •

GRAININESS METER



Alexander Goetz and W. O. Gould, of Caltech, with their microphotometer and photoelectric integrator used for examining the grain structure of motion picture film. The device examines the film under a microscope, plots its transparency curve as the film is moved. The area examined is so small that the individual grains in the emulsion are taken into account. The integrator is used to determine the fluctuations of transparency with respect to the mean value, and hence to indicate whether the graininess has a random distribution or results from some cause in the exposure and finishing processes. It has been found that the production of a positive film universally increases the graininess of the image

UNIVERSAL GAIN SET

A universal gain measuring instrument for rapid and accurate measurement of overall gain, frequency response, and power output of audio amplifiers.



Illustrated above: Type 685—complete set—width 19", height 7" (overall)—for standard rack mounting. Also available in portable carrying case at slight additional cost.

Individual panels available.

Type 688—Load Panel—top, above.

Type 683—Transmitter Panel—bottom, above.

The type 685 assembly offers in compact form an instrument for the rapid and accurate measurement of audio amplifiers, transmission systems, and attenuation networks over the audio range.

All networks, meters, and associated apparatus are thoroughly shielded, carefully balanced and matched to obtain uniform accuracy over a wide frequency range.

- ATTENUATION RANGE +10 db to -120 db in steps of 1 db.
- POWER MEASURING RANGE -20 db to +36 db.
- OUTPUT IMPEDANCES May be changed from Balanced to Unbalanced, and to any loss and impedance required by means of plug-in type matching networks.
- LOAD IMPEDANCE Eleven values, ranging from 5 to 600 Ohms, are available.
- FREQUENCY RANGE 20 to 17,000 cycles.
- ACCURACY OF ATTENUATION CONTROLS $\pm 1\%$.

Visit our booth at the IRE Convention

New York, June 16, 17, 18

Write for complete details.

THE DAVEN CO.

158-160 SUMMIT STREET, NEWARK, N. J.

MANUFACTURERS OF

Single and Dual Potentiometers
Special Rotary Switches
Filament Rheostats
Variable and Fixed Attenuators
Faders

Volume Indicators
Output Meters
Line Equalizers
Attenuation Boxes
Multipliers

Super Davohms
Laboratory Equipment
Speech Input Control Apparatus
Decade Resistances
Resistances
Davohms

Phone: Market 2-2468

For Manufacturers Looking For New Business— **ELECTRONICS** is an effective . . . inexpensive market research medium

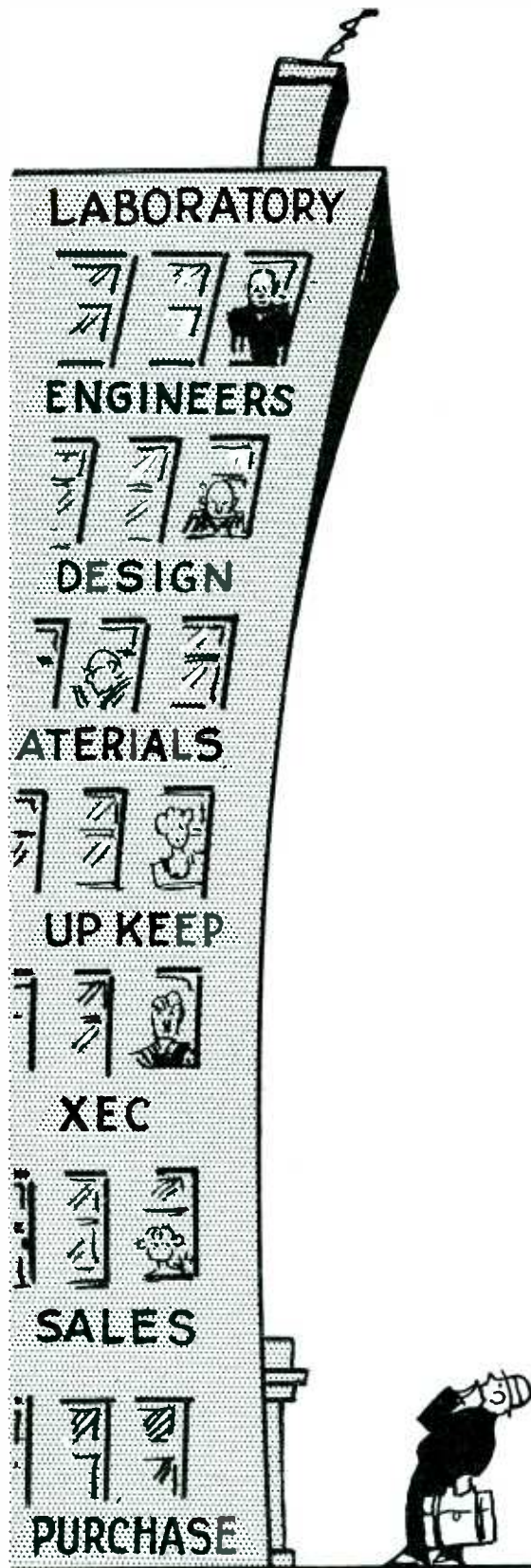

More than 13,000 Executives, Engineers and Researchers pay \$5 for twelve issues because they find it an invaluable source of information covering the development of the allied fields of the electronic arts.

AND

A CATALOG OF ADVERTISING OF THE BEST EQUIPMENT AND MATERIALS AVAILABLE

These paid subscribers are the important men and companies in radio — television — facsimile — broadcasting — police — aircraft — point-to-point — marine — telephone — telegraph communication — public address and sound picture equipment and studios — non-communicating electron tube equipment — electrical measuring equipment — therapy — electrical manufacturing — processing — fabricating — university laboratories — Governmental departments, etc.

A GOOD EXPORT PAPER

Advertisers are finding foreign markets, too, through ELECTRONICS' 2,400 subscribers in 50 countries throughout the world. One export house is using full pages solely for foreign.

ELECTRONICS OPENS NEW MARKETS FOR . . . Acoustic materials — alloys — batteries — cabinet materials — electrical controls — escutcheons — fasteners, bolts, nuts, washers, rivets — fuses — generators — insulation — magnetic material — measuring instruments — metals — meters — motors — packing cases and material — plastics — radio components — recording equipment — relays — switches — testing apparatus — transformers — tubes — varnishes and waxes — wire etc, etc.

ELECTRONICS is the One Magazine Which Digs Into Inaccessible Design Headquarters and Comes Up With Orders

Add ELECTRONICS to Your Sales Organization

Operating Conditions Affecting Inter-Electrode Capacitance

IN THE MARCH, 1938, issue of the *Proceedings of the Wireless Section, Institution of Electrical Engineers of London*, T. I. Jones discusses "The Dependence of the Inter-electrode Capacitances of Valves upon the Operating Conditions."

The results of the measurement at a frequency of one million cycles per second of the effective inter-electrode capacitances under working conditions of a variety of valves are tabulated, together with an estimate of the net capacitance residing between the active elements themselves.

The grid-filament capacitance shows an increment which increases with anode current up to the point at which the grid current flows. The increment diminishes at a given value of anode current as the anode voltage is increased. Experiment shows that this increment in capacitance is not a simple function of the anode current, neither of plate-filament current nor of mutual conductance. It is augmented the higher the filament temperature and is probably a function of the initial velocity of the electrons.

The effective grid-plate capacitance suffers a reduction as the plate current increases, but the reduction is much smaller proportionally than the increase in grid-filament capacitance.

Every type of tube examined displays the effect—even the small acorn triode and pentode in which the increment represents a 50 per cent augmentation of the "cold" value of the grid-filament capacitance.

• • •

RADIO WARNING FOR MOTORISTS



Leroy Clausung and J. E. Smith with their radio transmitter, placed at railroad grade-crossings and put into operation by the approach of a train. The signal, operating through the car radio, gives audible warning and lights a red light on the dashboards of automobiles approaching the crossing. The transmitting antenna consists of a wire strung along the side of the road for one-quarter mile



KENYONS

Save Costly Equipment and Servicing at WLW

AN EXAMPLE OF KENYON engineering ingenuity and ability to build transformers in accordance with close specifications is evidenced in the 500 kilowatt transmitter at the Crosley Radio Corporation station, WLW, Cincinnati, Ohio, "The Nation's Station". This transformer installation, consisting of a bank of 60 high reactance self-starting units, shown above, replaces three 1500 ampere generators previously employed to supply 150,000 watts filament heating power to twenty 100 kilowatt water cooled tubes.

These transformers are of special regulating design representing the first installation in which step-starting for warming up tube filaments has been eliminated. No necessity of employing low reactance transformers with complicated timing relays and equipment which requires considerable servicing!

Write Now! Submit your transformer problems for engineering collaboration. Our engineers will gladly cooperate in offering suggestions and supply quotations on your requirements.



KENYON TRANSFORMER COMPANY, INC.

840 BARRY STREET

NEW YORK, N. Y.

Export Department 25 Warren St., New York, N. Y.

GENUINE *Sapphire* NEEDLES

For TRANSCRIPTIONS or SHELLAC RECORDS... cannot injure Acetate

The Walco Sapphire disposes of the needle problem. The weakest link is now the strongest. A necessity for every phonograph in studios, laboratories, broadcasting stations and homes.

NEEDLE LIFE:
5,000 Acetate records
3,000 shellac records

(FROM ACTUAL SHADOWGRAPH TRACINGS)

RECORD LIFE:

Acetate records show no signs of wear after 150 playings; shellac 300.

SPECIFICATIONS:

Genuine sapphire tip ground to .0023 radius, 40 degree angle, set in special non-resonant alloy. PERFECT POLISH: This must be seen under a microscope to be appreciated.

RESPONSE:

Substantially same as best steel needle; no peaks, much lower surface hiss.

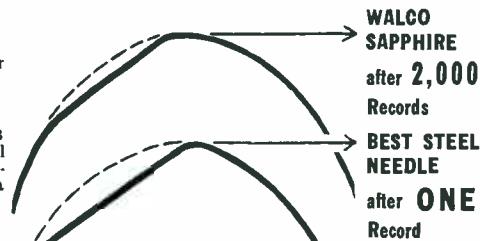

List Price \$2.00 — Money-back Guarantee



Phone: Plaza 5-0945

Cable: Walvox

ELECTROVOX CO., 424 Madison Ave., New York City
REPRESENTATIVES WANTED



CETRON

Photo cells, mercury vapor rectifiers, vacuum gauges (Perani type), vacuum power switches and other vacuum products.

Research and production divisions equipped for development and production of your special vacuum product requirements.

CONTINENTAL ELECTRIC CO.

HAMILTON STREET

GENEVA, ILLINOIS



ENCLOSED RELAYS

That Operate in Any Position

Available in Power, Vacuum Tube and Radio Frequency Types.

Especially adaptable for mobile, marine, aircraft and police installations. AC and DC.

ALLIED CONTROL CO., INC.

95 Liberty St.

New York, N. Y.

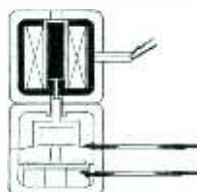

Beam Tube for Ultra-High Frequencies

CONSIDERATION IS given to the deflection of a focused beam of electron as a possible basis for the construction of tubes intended to be used for operation in the ultra-high frequency spectrum, in an article by F. M. Colebrook in the April issue of *The Wireless Engineer*. Ordinary negative grid tubes are limited in their upper frequencies by the absorption of power in the grid circuit which is associated with and due to the transit time of flight of the electrons. The author suggests, as an alternative to existing methods of control, control of the electron current by forming it into a focused beam as in

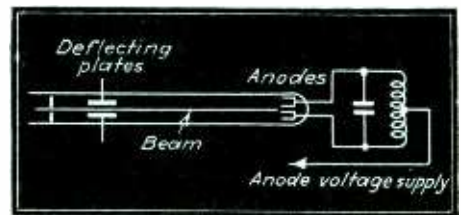

Tube with directed electron beam deflected by electrostatic field, intended for ultra high frequency operation

a hard cathode ray tube and directing this beam between electrodes to which the high frequency voltage is applied, thus causing a periodic deflection of the beam. With this method, the beam can be controlled so as to deflect to and fro between two suitable anodes as shown in the accompanying diagram. By connecting these anodes to a suitable resonant impedance, tapped at the center, a high frequency voltage may be produced across this circuit. The voltage thus produced may be used to deflect the beam by applying it to the deflection plates, or the voltage may be subsequently amplified if desired.

• • •

EDINBURGH'S TALKING CLOCK



Very popular and profitable talking-clock installations have been made by many European telephone companies. One of the latest is this equipment in the Edinburgh exchange

Input Console

(Continued from page 41)

The purpose for which each amplifier is used is shown below:

- Pre-amplifier 1. Control room microphone and Lobby microphone through switch.
- Pre-amplifier 2. Studio A-1 microphone and Studio B-2 microphone through switch.
- Pre-amplifier 3. Studio A-2 microphone.
- Pre-amplifier 4. Studio B-2 microphone.
- 40-C line amplifier Feeds program to transmitter. (Input connects to output of program mixer.)
- 94-C amplifier 1. Normally used to drive all loudspeakers switched to "local" channel. (Input bridges across 40-C output through switch on input selector panel.)
- 94-C amplifier 2. Normally used to drive all speakers switched to "audition" channel. (Input connects to output audition mixer through switch on input panel.)
- AA-4194-B amplifier. Normally used drive all speakers switched to NBC channel. (Input connects or bridges across NBC line through switch on input panel.)

Automatic Frequency Control Systems

By JOHN F. RIDER. (140 pages, John F. Rider Publishing Co., New York. Price \$1.00.)

The advent of AFC systems brings many problems to the service man. Mr. Rider, who is the service man's god, more or less, has seen the need for something on this subject and has produced it as a member of his series of little books for practical service men. He discusses such matters as the discriminator circuits and how they work, how the oscillator frequency is controlled automatically, and then plunges into a useful description of commercial AFC circuits and how to make them go back to work when they strike.

NEW PRESTO RECORDING EQUIPMENT FOR STUDIO INSTALLATIONS



THIS heavily constructed mounting table finished in durable black hard rubber enamel will improve the appearance of any recording installation. It makes an ideal permanent mounting for the Presto 61-C or 6-D turntable chassis. Measurements are—Length 52", Depth 32", Height 40". Two cut-outs are provided to hold the turntables flush with the table top. There is space between the turntables for mounting faders, filter networks, meters, or needle cups.

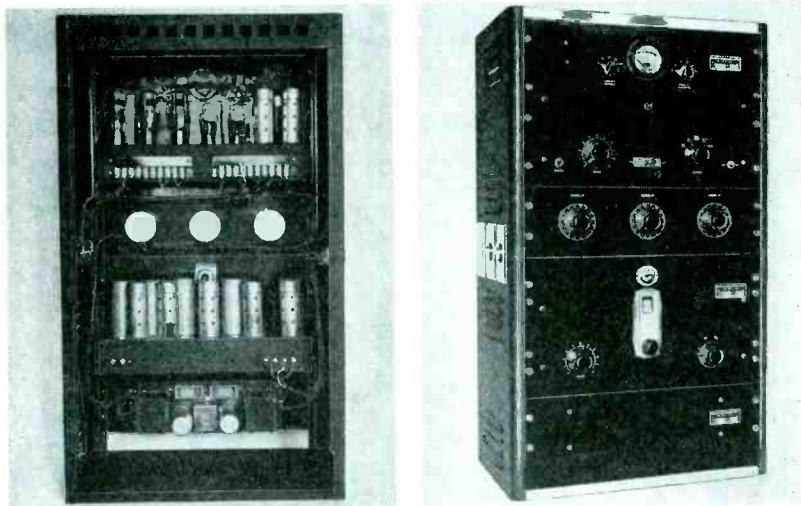

A NEW, compact input system for recording, consisting of recording amplifier, high-frequency equalizer, three-channel mixer, TRF band-pass radio tuner and preamplifier. A power supply in the main amplifier furnishes power for the radio tuner and preamplifier, operates from the AC line. Equipment handles two turntables for continuous recording off the air, off the line or from the studio. Also simultaneous recording on two discs and dubbing.

Write for catalog giving performance specifications and prices of individual units.

PRESTO RECORDING CORPORATION
143 WEST 19th STREET
NEW YORK, N. Y.

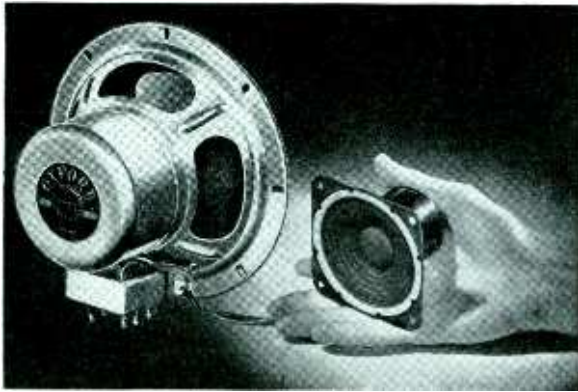

OXFORD

- ★ Permag-Dynamic
- ★ Electro-Dynamic
- ★ Magnetic

SPEAKERS

3" to 14"

CUSTOM-BUILT TO YOUR SPECIFICATIONS

Speakers of outstanding quality, accurately built to manufacturers' specifications. Write us about your special needs—let us help you work out your speaker problem. No obligation.



IN STOCK READY TO SHIP

A complete stock of Replacement and Public Address Speakers carried in stock for your convenience. Standard numbers can be shipped directly upon receipt of orders.

Test the 1938 Oxford Speakers! Note how well Oxford will suit your requirements, whether for original installation or replacement. There is the remarkable 3" Permag which made so sensational a hit and solved many sound application problems—and other popular models up to the 14" Permag or Electro-Dynamic units—all built right and priced right! It is a matter of record that Oxford Speakers are widely used in radio sets and public address systems by prominent manufacturers, sound engineers and servicemen.

Write Dept. "E" for complete data and information.

NEW YORK OFFICE: 27 PARK PLACE, NEW YORK CITY



WHY use "MAKESHIFTS"?

THE CANNON Line of Cable Connectors is so diversified that innumerable adaptations can be made to meet special needs. In fact, many standard CANNON Plugs originated as adaptations of standard parts, which met with such universal acceptance for other applications that they, in turn, became standard.

Don't be satisfied with "makeshift" plugs. Consult Cannon . . . Perhaps adaptations can be made to meet your special requirements. Inquiries invited.

Cannon plugs are pre-eminent in aeronautics, sound-recording, geophysical research, ship-control-at-sea and for laboratory panels.

CANNON ELECTRIC DEVELOPMENT CO.

- ★ 420 West Avenue 33, Los Angeles, California
- ★ EASTERN SALES OFFICE, 220 Fifth Ave., New York, N.Y.

CANNON PLUGS



MICROHM WIRE WOUND RESISTORS

TYPE H and J MICA CARD with protected resistor element

Available in a resistance range from 10 to 50,000 Ohms; size: 1 1/2" x 2 1/4" x 1/8"; insulated eyelet mountings; 40 Watt; accuracy 2%. Resistance element sandwiched between TWO sheets of Mica. High overload safety factor, small size, accuracy and low price make these units ideal for many applications. Full details and prices on request.

PRECISION RESISTOR CO.

332 BADGER AVE.

NEWARK, N. J.

Manufacturers of custom built PRECISION and INDUSTRIAL WIRE WOUND RESISTORS.

What's New In Radio

[Continued from page 19]

A new wirewound resistor of Speer Carbon is attracting attention. The illustration describes its construction better than words can do. Increased use of graphite anodes for transmitting tubes is reported by Speer Carbon as a result of greatly improved appearance, greater ease of de-gassing and freedom from "dusting."

Push Button Tuners

Mechanical engineers have gone to town with push button tuning. Nothing that has hit the radio industry has given these men such opportunity. So rapid has been the development that the following brief survey of the present situation is necessarily incomplete and inadequate to cover the whole problem.

The new Oak selector has a minimum of 4 buttons, a maximum of 16, in a dual row of 8 each. Plunger arms are available in whatever length is necessary. Button spacing is variable. Plunger travel is three-quarter inch, an optimum distance of travel consistent with ease of operation and mechanical design. The unit is available with or without latch bar. The Yaxley MC switch features low capacitance between terminals and to frame, high insulation resistance, low contact resistance, low radio frequency losses, wiping contacts between heavily silver-plated terminals and sliding shoes supported on high grade low loss insulation. A bulletin issued by Mallory-Yaxley under date of April 20 gives an amazing listing of the uses to which this type of push button device may be put.

Permeability-tuned Push-button Converter

Meissner has a unit which permits permeability tuned station selection to be added to modernize any existing radio receiver, provided it uses a 456 to 465 kc intermediate frequency. This unit is completely enclosed in a

Now—
a high-powered—



New
The Library now comprises a revised selection of books culled from latest McGraw-Hill publications in the radio field.

RADIO ENGINEERING LIBRARY

— especially selected by radio specialists of McGraw-Hill publications

— to give most complete, dependable coverage of facts needed by all whose fields are grounded on radio fundamentals

— available at a special price and terms

These books cover circuit phenomena, tube theory, networks, measurements, and other subjects—give specialized treatment of all fields of practical design and application. They are books of recognized position in the literature—books you will refer to and be referred to often. If you are a researcher or experimenter—if your interest in radio is deep-set and based on a real desire to go further in this field—you want these books for the help they give in hundreds of problems throughout the whole field of radio engineering.

5 volumes 3064 pages, 2000 illustrations

1. GLASGOW'S PRINCIPLES OF RADIO ENGINEERING
2. Terman's MEASUREMENTS IN RADIO ENGINEERING
3. Chaffee's THEORY OF THERMIONIC VACUUM TUBES
4. HUND'S PHENOMENA IN HIGH-FREQUENCY MEASUREMENTS
5. Henney's RADIO ENGINEERING HANDBOOK

Special Low Price and Easy Terms

Bought singly, the five volumes comprising this library would cost you \$26.00. Under this offer you save \$2.50 and, in addition, have the privilege of paying in easy installments beginning with \$2.50, 10 days after receipt of the books, and \$3.00 monthly thereafter. Already these books are recognized as standard works that you are bound to require sooner or later. Take advantage of these convenient terms to add them to your library now.

SEND THIS ON-APPROVAL COUPON

McGraw-Hill Book Co., Inc.
330 W. 42nd St., New York, N. Y.

Send me Radio Engineering Library 5 vols., for 10 days' examination on approval. In 10 days I will send \$2.50, plus few cents postage, and \$3.00 monthly till \$23.50 is paid, or return books postpaid. (We pay postage on orders accompanied by remittance of first installment.)

Name

Address

City and State

Position

Company L-6-38

(Books sent on approval in U. S. and Canada only.)

metal housing and carries its own pentagrid converter. By using its own converter tube, the push-button assembly is free from complications that might be introduced in attempting to change the wiring in an existing receiver. The short wave bands sometimes refuse to work at all if the circuits are rewired to accommodate fully automatic condenser type push button tuners. All of this trouble is avoided in using a completely separate converter tube. The only adjustment changed in the receiver is the alignment of the primary of the first i-f transformer because of the addition of the capacity of an extra pentagrid plate circuit which is permanently connected. The switching of oscillator is accomplished in the cathode circuits.

"110 Volts Anywhere"

Most rapid has been the development of power conversion devices for operating radios, public address systems, transmitters, etc., from batteries, or from the motive power supplied by the rear wheels of an automobile. Very active in this field are Pioneer (Genemotor) and Janette. Other manufacturers such as Onan and Sons, and Kato, build small lighting plants d-c or a-c, for remote locations. Many of these units are portable, and represent lots of power for the weight. Sound picture equipment, portable X-ray apparatus, farms, camps all come within the range of loads economically supplied with power by such apparatus. Recent machines supply both a-c and low voltage d-c (12 volts) for battery charging, useful during the time the generator is not running.

Electronic Laboratories have further developed their line of converters operating on the vibrator principle so that all manner of power supply is available for electric clocks (variable frequency converter) Hammond organs, PA systems, recording instruments—even a-c phonograph turntables. At the Chicago Parts Show a 2 kw vibrator was exhibited. Weight-power ratio may be illustrated by the fact that a 3 lb. vibrator will supply 300 watts of power.

Electro Products Laboratories (Alfred Crossley) have produced units which provide power for 2-volt radios from 110 volts a-c. Filters to keep down the hum, output inde-

"PINCOR"
SILVER BAND
DYNAMOTORS



Now..Choose the Unit that Fits the Job..

★ "PINCOR" offers the only complete line of "B" power supply equipment for police units, aircraft and radio broadcast service and sound systems. Available in a wide range of frames, sizes and capacities to fit any particular requirement.

★ "PINCOR" dynamotors are the last word in efficiency and regulation. Deliver high voltage current for proper operation of your apparatus with a minimum of A.C. ripple. These units will give years of smooth, quiet, satisfactory service. They are compact, light weight. Available with or without filter.

NEW CATALOGUE FREE

Send for the latest "PINCOR" dynamotor catalogue and data sheets which includes description of the new types, "PS," "CS," and "TS" dynamotors. Mail coupon below.

PIONEER GEN-E-MOTOR CORPORATION
466 W. SUPERIOR ST., CHICAGO, ILL.
Export Address: 25 Warren St., N. Y., N. Y.
Cable: Simontrice, New York



Send for
FREE
Copy!

Mail Coupon
Today

PIONEER GEN-E-MOTOR CORPORATION
Dept. R-4-F, 466 West Superior Street, Chicago, Illinois
Without obligation kindly send me "PINCOR" Silver Band Dynamotor catalogue and data sheets.

Name

Address

City State

AUDAX

**Compensated-Inductor
MICRODYNE**

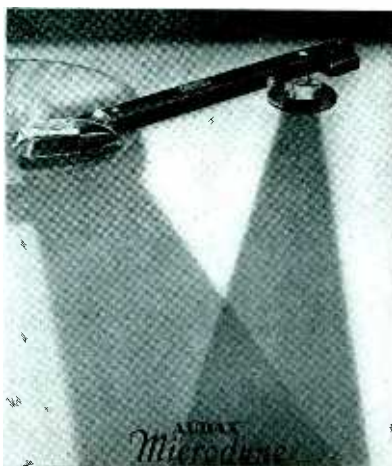

*"The standard
by which others are
judged and valued"*

THE "RELAYED FREQUENCY" MICRODYNE is now standard in Leading Radio Stations, Studios, Laboratories and wherever quality sound is paramount. Through constant refinements it now has a FLAT response within ± 2 db, over the entire recorded spectrum and operates with but a few grams on the record.

In the startling development here presented, for use where price is a factor, a new type inductor is so coupled by a mechano-low-pass filter (a Semi-Crystallized ingredient, — not piezo-electric), as to boost the bass frequencies, thus compensating for this well known deficiency in the record itself. Result:—a marvelous facsimile realism all the way UP and all the way DOWN.

Note These Features:

- Delivers consistently uniform response indefinitely, with the sharp, clean-cut definition of the finest magneto-inductive pickup
- FLAT from 350 cycles up, and compensatory gradually rising characteristic from 350 cycles down, reaching about 14 db at 46 cycles
- Absolutely immune to moisture and temperature changes
- High voltage output sufficient for practically any amplifier
- Available in any impedance
- Small, beautifully streamlined offset head, AUDAX-engineered, easily adaptable to any automatic changer arm
- Considerably lighter pressure on record than any other commercial pick-up—no record wear
- Equipped with instant tip-jack connectors
- Needle impedance is exceptionally low
- Equipped with newly developed Needle Guide
- Immune to stray fields
- New non-resonant arm—precision ball-bearings
Costs no more than ordinary pickups

Write for new literature

AUDAX COMPANY
500 Fifth Ave. New York City

"Creators of High Grade Electrical and Acoustical Apparatus Since 1915"

pendent of line voltage variation over wide limits, efficiency of output compared to power taken from the line (7-tube set requiring 30 watts, a-c) are the outstanding characteristics of these A-B eliminators.

A Raytheon rectifier provides 120 watts of d-c (300 volts at 0.4 amps.) from 115 volts a-c with ripple down 80 db at 0.2 amps., with good regulation. Another "rectifier" delivers 5 to 24 volts at 0 to 4 amps. Voltage regulators, magnetic in principle, are also available from Raytheon. These units will maintain voltage to very close limits. Recent units provide low voltage output (6 or 7.5 volts).

Other types of magnetic regulators have been developed recently by Dr. Palmer Craig of the Invex Corporation and are distributed by Roller Smith.

Television Receivers

No pre-season survey would be complete without a description of the television receivers displayed in New York late in May by Communication Systems, Inc. Using a 3-in. standard oscillograph cathode ray tube (2½-in. picture), the sight and sound receivers are separate. The sight circuit comprises two stages of r-f (1851 tubes), an 1851 detector, 1851 first video, a 25L6 video output tube and a 6H6 sync separator. The high voltage rectifier is an 879; an 80 supplies low voltage. Vertical synchronism is had through the 60-cycle power line; gas-filled tubes provide 60 cycle sweep voltages and three vacuum tubes provide the required 13,320 cycle sweep voltages. There are 14 tubes in all, including rectifiers and cathode ray tube and the suggested list price is \$125. A 5-in. cathode ray tube model (3 in. picture) utilizes a voltage of 2000 for the cathode ray tube. Otherwise the receiver is like the cheaper model.

Late in the month Alden Products disclosed a very wide range of connectors, sockets, plugs, grid caps, braided conductors, cables, pilot lamp sockets and all manner of these small parts which play an important although often unseen role in radio receiver and transmitter construction.

Headsets brought up to date are represented by Trimm's commercial unit. Available in 600 or 17,000 ohms impedance per pair, they list at \$16.

COLLOIDAL GRAPHITE.....

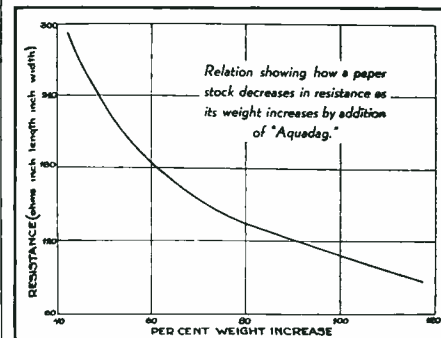

an IMPREGNATING MEDIUM

Dispersions of colloidal graphite, when incorporated in a variety of materials like cloth, felt, leather, paper, asbestos, etc., by impregnation techniques, impart thereto qualities of lubricity, conductivity, and coloring.

For example, Paper Stock is rendered opaque and electrically conductive either by passing it through agglomerate-free baths of aqueous colloidal graphite (like "Aquadag") or by adding the same material to the beaters at the time of the paper's fabrication. The increase in conductivity per weight of colloidal graphite added is shown above.

Asbestos is best impregnated when "Aquadag" or "Prodag" are added to the beaters as in the case of paper.

Leather and lignous substances are treated by simple soaking or saturation, centrifugal-pressure devices being used to obtain the best results.

Just as graphite is added in paper at the time of its manufacture, so products like wax, "Cellophane," rayon, "Bakelite," soap, calcined gypsum, etc., can be treated by using colloidal graphite in their respective formulae.

Write for Bulletins 210, 230, A260, B260.

dag
THE
COLLOIDAL
PRODUCTS

ACHESON
COLLOIDS CORPORATION
PORT HURON - MICHIGAN

Electronics in Sales Promotion

[Continued from page 25]

digit dialed. Inside the window and directly opposite the outside coil is another inductance of similar characteristics, it being attached to the window by a cellophane adhesive tape. A simple transmission line from an oscillating tank circuit is connected to the inside of the window coil. A relay connected in the plate circuit of the oscillator opens each time the outside coil becomes resonant to the inside coil. An extension speaker was mounted on the store marquee. The musical instruments were mounted on motor-driven turntables skirted with translucent lamicoid and back illuminated.

An exhibit of unusual character is shown in Fig. 1. Here a vacuum cleaner travels over a sheet of plate glass without visual wire or connections. The cleaner travels only on command when passerbys are compelled to say 'Me for a G.E.' No other words or sequence of words will cause the exhibit to go into operation; this is because of a combination of syllabic impulse and frequency band-pass filter circuits. Power is supplied to the cleaner by a third rail system placed on the edge of the carpet. Collector brushes are inserted in one of the rear guide wheels of the cleaner below the carpet edge. The cleaner only travels over a half-section of carpet so that only one-half of the sweeper action is exposed through the glass. A mirror placed at right angles below the glass and arranged at an angle to prevent the rear contact wheel from being seen, reflects the movement. Structural glass internally illuminated by motor-driven color wheels forms the support for the display. A time delay relay governs the cyclic operation of the exhibit.

The control microphone is housed in a steel box and mounted like the dial operated unit previously described. Coils are placed on both sides of the window to effect absorption modulation in the tank circuit of a low-power oscillator. A coupling network links the oscillator directly to a detector and power amplifier and the output is made to energize

BEAT FREQUENCY GENERATOR

Type 140-A

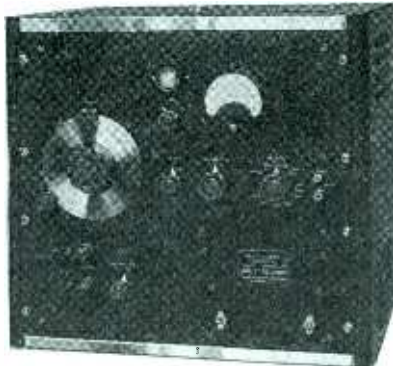

Features:

- Frequency Range—20 cycles to 5 megacycles.
- Voltage Range—1 millivolt to 32 volts.
- Power output up to 1 watt.
- Output level constant within ± 2 DB.
- Low order of harmonics.
- Direct reading calibrations.
- Cabinet or relay rack mounting.

A generator of signal voltages, continuously variable over a wide frequency and voltage range. Especially useful for the design of wide range transformers, amplifiers, transmission lines, television systems, etc. Also as a modulator of signal generators.

Write for descriptive circular

BOONTON RADIO CORPORATION
BOONTON, NEW JERSEY, U. S. A.

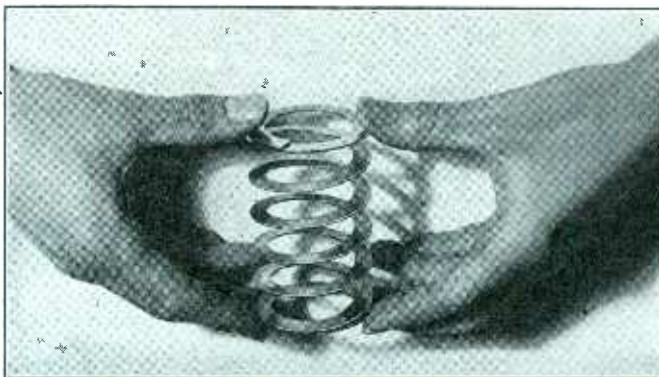

SPRINGS by HUNTER

All types, all sizes, all materials. Design and production — every phase of the job, promptly and economically handled by experts now serving some of the country's leading manufacturers. Write for free literature.



Modern facilities for parts assembly work.
AT LANSDALE, PENNSYLVANIA

HUNTER PRESSED STEEL CO.



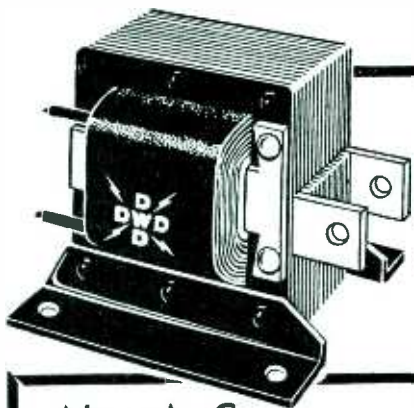

The LAST WORD IN SOLENOIDS

New A. C. SOLENOID

3 Sizes: 1½" x 1½"
2" x 2"—4" x 4"
Any Voltage

★ The New A. C. Solenoid is complete in every detail and represents the results of careful and scientific research and manufacture. It will improve the operation of your equipment at a probable saving and give longer life with greater dependability.

We make coils of all types—precision coils for the most exacting requirement. Davis coils are fabricated from high quality material by men who are experts in their craft. Let our Engineering Department solve your coil problems—there is no obligation.

Davis also manufactures special purpose relays. We are now developing a new silent A. C. Relay which we will soon announce. Let us send you advance information on its technical characteristics.

Write for literature and further details on all of our products.

DEAN W. DAVIS & CO., Inc.
551 W. FULTON ST.
CHICAGO, ILL.



MONARCH MULTIVIBRATOR

★ . . . speeds production . . . makes quick accurate alignment possible . . . prevents rejects and returns. The MULTIVIBRATOR supplements the signal generator and has proved beyond doubt that it is an absolute necessity. It is standard equipment with many of the world's largest set manufacturers. Let us give you further technical details and prices.

MONARCH MANUFACTURING COMPANY
3341 BELMONT AVE., CHICAGO ILL.



Frequency Measuring Service

Many stations find this exact measuring service of great value for routine observation of transmitter performance and for accurately calibrating their own monitors.

MEASUREMENTS WHEN YOU NEED THEM MOST
at any hour every day in the year

R.C.A. COMMUNICATIONS, Inc.

Commercial Dept.
A RADIO CORPORATION OF AMERICA SERVICE
66 BROAD STREET NEW YORK, N. Y.



an impulse locking relay to close a local circuit to a rotary selector switch which advances according to the number of syllabic impulses spoken. The first impulse closes the impulse relay and locks it, and at the same time steps up the rotary switch arm to the first contact point completing a transfer circuit so that the next input impulse passes through a band-pass filter, if of the proper frequency it will close a relay in the associated circuit advancing the rotary switch arm to another contact point inter-connecting



Fig. 5—By use of a capacity type relay, the receiver inside the store window may be tuned from the street

still another circuit for opening the impulse locking relay. The locking, opening and stepping-up sequences continue until the required number of syllabic and frequency impulses have advanced the selector switch to the proper operating contact point to cause the a-c power relay and time delay relay to close. A five impulse system was used, and only the second and fifth impulses (Me for a G. E.) were frequency selective. If an improper series of words is spoken, an auxiliary holding relay restores the selector switch one-second after the last improper syllable has been uttered. Only the correct words spoken in their respective order will make the cleaner operate.

Capacity Relay Application

An exhibit incorporating a capacity switch was very successful in pro-

Finch Facsimile

LEADS THE WAY

FIRST to open the NEW field in "Home" Facsimile broadcasting.

FIRST SYSTEM placed in actual operation by the MAJORITY of MAJOR facsimile broadcasting stations.

FIRST to PERFECT automatic, fully visible, continuous feed "HOME" recorders, requiring neither liquids nor carbon transfer sheets.

FIRST to develop an automatic selective synchronizing method which permits "HOME" facsimile recording in all AC or DC power areas.

The FINCH laboratories are open to licensed broadcasters for demonstration, by appointment. Call Plaza 5-6570.

FINCH TELECOMMUNICATIONS LABORATORIES, INC.
37 West 57th Street
New York City

PLUGS — SOCKETS
TERMINAL PANELS, ETC.

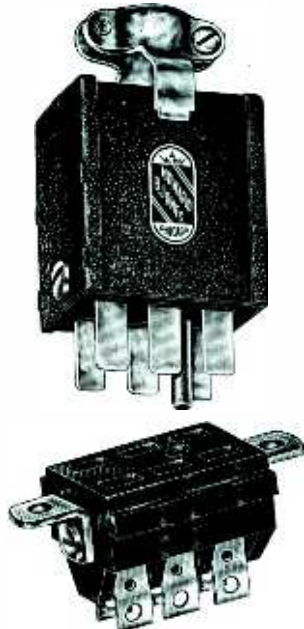

ILLUSTRATED
PLUG: P-6-CCT—SOCKET: S-6-AB

HUNDREDS OF STANDARD ITEMS OR SPECIALS TO YOUR BLUE-PRINTS.

WRITE FOR BULLETINS.
HOWARD B. JONES
2300 Wabansia Avenue
CHICAGO ILL.

Precision Products. 39-page catalogue containing physical dimensions, electrical characteristics, drawings and circuits applicable to many products of P. R. Mallory & Co., Inc., Indianapolis, Ind.

Transformers. "Broadcast Developments" bulletin lists "Ouncer" high fidelity audio units, recording equalizer, remote amplifier, and control units. United Transformer Corp., 72 Spring Street, New York City.

Recording Equipment. 8-page bulletin, "Fine Points in Recording". By Allied Recording Products Company whose address was listed improperly last month. The correct address is 126 West 46 Street, New York City.

Corrosion Booklet. Summarizes studies and experience of chromium chemical as corrosion inhibitors. Mutual Chemical Co. of America, 270 Madison Ave., New York City.

Electronic Tube Prices. W. L. Form S-860. Current prices of industrial tubes and industrial tube sockets. Lamp Division, Westinghouse Electric & Mfg. Co., Bloomfield, N. J.

Recording and Playback Needles. 4-page pamphlet describing various types of sapphire needles and points. Meyer Koulisch Co., Inc., 64 Fulton St., New York City.

Mercury Switches. A 12-page bulletin showing a wide variety of mercury switches together with their capacity ratings. General Electric Vapor Lamp Co., Hoboken, N. J.

Small Motors. Bulletin 1020-A gives specifications for fractional motors having ratings of from 1/6 to 1/2000 hp. Bodine Electric Co., 2254 W. Ohio St., Chicago.

Sound Equipment. Loud speakers and related equipment described in bulletins No. WX8-12 and F-38. Atlas Sound Corp., 1447 39th St., Brooklyn, N. Y.

Sound Systems. 1938-1939 catalog of Clarion "Unified" sound systems. Clarion Institute of Sound Engineers, 69 Wooster St., New York City.

Loud Speakers. No. R17, a standard specification folder describing 66 models of loud speakers. The Magnavox Co., Fort Wayne, Ind.

Loud Speakers. 16-page loose-leaf catalogue describing complete line of electro-acoustic devices. Racon Electric Co., 52 East 19 St., New York City.

Rangertronics. New house-organ dealing with electrical methods of producing and reproducing music. Rangertone, Inc., 201 Verona Ave., Newark, N. J.

Advertisement

Stopped by a Crack

THE ILLUSTRATION shows a combination oscillator and control unit designed and built by Raytheon to drive an electrical fatigue testing machine. This is a machine which flexes a metal bar so rapidly that it breaks from fatigue in a matter of minutes, as contrasted with days or weeks required by mechanical testing methods. The problem was to maintain the vibration of the metal bar at constant amplitude and frequency and to shut off the oscillator the instant the bar cracked so that the number of flexes required to produce failure could be accurately determined. This was no easy problem to solve because at the instant the crack formed it was so small that it was invisible to the naked eye. To get the solution, a thorough knowledge of electronics, optics, timing, temperature, and vibration was required.

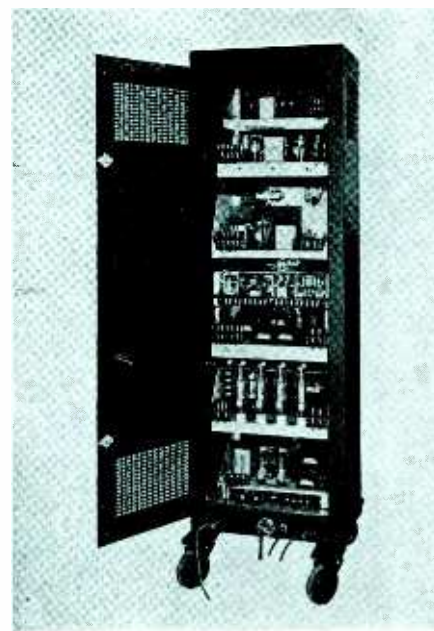

Because Raytheon has a skilled and versatile organization, manufacturers and inventors of electrical and electronic devices for industry bring ideas to us to be developed and then manufactured in volume production. The manufacturers come because we produce faster, better, or cheaper than they can—leaving their organizations free for other duties. The inventors come because we have had 19 years' experience in shaping their ideas into commercial form.

Some of the largest electrical equipment manufacturers in the country have dealt with us for years on the basis that they present the problem and we do the rest. They find it to their advantage to do this even though they have complete design and manufacturing facilities of their own. Raytheon offers this same electrical engineering service to you—an organization to work in strict confidence with you either on the design of a new product or its construction to your specifications. We have representatives in principal cities. Write today to Raytheon Manufacturing Company, 100 Willow Street, Waltham, Mass., outlining your needs and we shall arrange to have a competent engineer interview you at your convenience.

INSUROK

The Superior Plastic Molded or Laminated for all Electrical Insulation

IN no industry are demands for electrical insulation more varied and exacting than in the field of electronics. INSUROK, the superior plastic, and Richardson facilities for precision manufacture of difficult and intricate molded and laminated parts and products, form an unequalled combination to successfully meet every electrical requirement and provide a wholly dependable, single source of supply.

Write for complete details and copy of INSUROK catalogue.

The RICHARDSON COMPANY
 MELROSE PARK, CHICAGO 41, ILLINOIS 1949 LANSING, MICHIGAN 1949
 NEW BRUNSWICK, N. J. INDIANAPOLIS, INDIANA 1949
 NEW YORK OFFICE: 4122 E. M. BUILDING, FRONT STREET AND 10TH AVENUE, NEW YORK 17, N. Y.

New Products

Gammatron

THE TYPE 254 GAMMATRON recently announced by Heintz & Kaufman Ltd., South San Francisco, Cal., is a triode having a plate dissipation of 100 watts and a maximum Class "C" power amplifier capability of 500 watts output. The Class "B" audio output for 2 tubes is 450 watts. Having no internal insu-

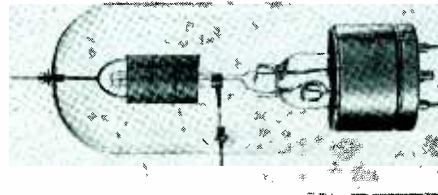

lators and using tantalum elements, Nonex envelopes and tungsten supports, the tube is particularly designed for ultra-high frequency operation and will give good power output at 5 meters. Ratings are as follows: filament voltage 5; filament current 7.5; normal plate dissipation 100 watts; maximum plate current 200 ma.; maximum plate volts 3000; and maximum grid current 40 ma.

Ventilated Type Resistors

OHMITE Mfg. Co., 4835 W. Flournoy St., Chicago, Ill., announces new ventilated cage type resistors of three sizes, for one, two, or four resistors with overall dimensions of 2 1/2 in., 2 3/4 in., and 4 1/2 in. respectively x 9 1/8 in.



long, with mounting centers of 8 3/8 in. The cage resistors are suited for use where it is desired to prevent accidental contact with the resistor. They can be mounted on switchboards and test panels, etc., in control, protective, or line voltage dropping circuits, where wattages up to several hundred are to be dissipated.

ECCO HIGH FREQUENCY CORP.

120 WEST 20th STREET
NEW YORK, N. Y.

THE MOST MODERN BOMBARDING EQUIPMENT

- Incorporates Straight line power output control
- Balanced low loss circuits
- Simplicity of operation
- Safety, rugged construction and many other New and Exclusive features

Units from 1 1/4 to 30 Kva.

Mica Condensers, Heater Coils, Watercooled City Cables and other replacement parts for your present bombing equipment.

"MEGGER"

TRADE MARK REGISTERED U.S. PAT. OFF.

INSTRUMENTS

Today the trade-name "Megger" embraces a wide variety of portable direct-reading instruments for measuring—

- insulation resistance up to 10,000 megohms,
- conductor resistance down to .000001 ohm,
- ground resistance in ohms, capacitance in microfarads, and water purity in units of conductivity.

Appropriate literature will be sent gladly upon request.

JAMES G. BIDDLE CO.

ELECTRICAL INSTRUMENTS
 1217-13 ARCH STREET PHILADELPHIA, PA.

Equalizer Panel

FOR USE IN CORRECTING frequency characteristics of circuits for transmission and amplification of music and speech in radio broadcasting and in recording, a new equalizer, known as AmerTran Type F-188, is espe-

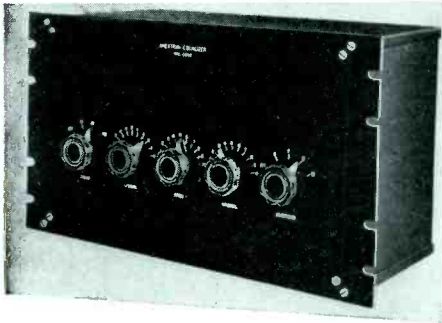

cially intended as a general purpose panel for equalizing lines which are not in continuous service. It is a new product of the American Transformer Co., 178 Emmet St., Newark, N. J.

Equalization at 25, 50 or 100 cycles can be controlled throughout a range of 0 to 25 db in eleven steps. The same type of control is available for frequencies of 5, 7, 8 or 10 kc and is also obtainable in an 11-step 30 db master attenuator which controls insertion loss at 800 cycles and determines the maximum available equalization.

The F-188 equalizer operates at levels up to plus 20 db and offers a nearly constant impedance of 500 ohms without introducing appreciable harmonic distortion.

Amateur Transmitters

A KNOCK-DOWN, PUSH-PULL radio frequency power amplifier in kit form, designed to use any of the popular triode tubes having ratings of from 100 to 300 watts output per pair, is announced by Hammarlund Mfg. Co., 424 West 33d St., New York City.

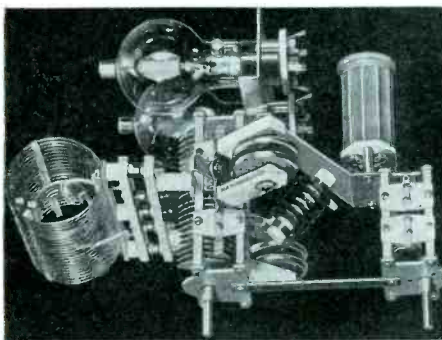

The transmitter comes in approximately 10 parts including condensers, coil forms, complete set of hardware, etc., and is easily constructed by amateurs and others without extensive mechanical equipment or ability.

ELECTRONICS — June 1938

BAREX GETTERS

SIZE IS SECONDARY

The fact that we are the world's largest producers of Getters is important to you only because of the reasons responsible for this growth. Specialization in just one product, constant improvement and controlled laboratory methods have made Barex Embedded Getters the accepted standard among top-quality tube manufacturers. An unusually wide range of sizes, shapes and compositions enables us to meet your specifications exactly and promptly. Write for samples and quotations.

KING LABORATORIES, INC.
SYRACUSE, N. Y.

immediate delivery

Our modern, efficient delivery system cuts time in half. Regardless of quantity or variety, shipments of **Turbo Oil Tubing** and **Saturated Sleeving** are made the same day your order is received.

When you place your order for **Turbo Oil Tubing** and **Saturated Sleeving**, you are getting the finest cotton tubings on the market, **thoroughly impregnated inside and out.**

STOCK ON HAND IN NEW YORK CITY & CHICAGO

TURBO

INSULATING MATERIALS

Write today for descriptive literature & samples, Dept 106

Other Turbo Products
Varnished Silk Varnished Paper
Varnished Cambric Block Mica
Built-up Mica Plate
Mica Condenser Films

WILLIAM BRAND & COMPANY

268 Fourth Ave., New York, N. Y. • 217 N Desplaines St., Chicago, Ill.

New

SENSITIVE ELECTRONIC AC VOLTMETER MODEL 300



10 to 100,000 cycles
Range .001 to 100 volts
Logarithmic scale
AC Operated
Stable calibration
Accurate and compact

Operating on a new principle—capable of reading down to .001 volt and up to 100 volts over the audio, carrier and supersonic ranges of frequencies with an overall accuracy of 2%—single (logarithmic) scale to read for all five ranges—unaffected by changes in line voltage or tube characteristics—can also be used as 70 DB amplifier, flat to 100,000 cycles.

Send for Bulletin 2B for full data.

Ballantine Laboratories, Inc.

BOONTON

NEW JERSEY

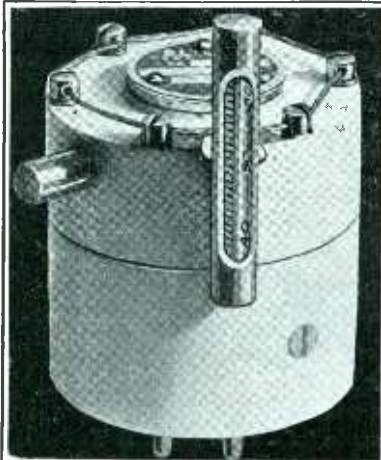

BLILEY CRYSTALS, HOLDERS

Precision manufacturing facilities and correctly designed holders assure dependable frequency control for any frequency from 20 Kc. to 30 Mc. For technical recommendations on standard or special applications, a statement of your requirements will receive immediate attention.

BLILEY ELECTRIC CO.
UNION STATION BLDG. ERIE, PA.

WAXES • COMPOUNDS • VARNISHES for ELECTRICAL INSULATION

Zophar offers prompt service on Insulating Compounds for a wide variety of electrical applications, including:

... insulation for CONDENSERS, TRANSFORMERS, COILS, power packs, pot heads, sockets, wiring devices, wet and dry batteries, etc. Also WAX SATURATORS for braided wire and tape. WAXES for radio parts.

Special compounds made to your order.

ZOPHAR MILLS INC.

130-26th St.

Brooklyn, N. Y.

FOUNDED 1846

Low Power Transmitters

COMPLETELY ASSEMBLED, compact, portable transmitters known as types PTR and PTRX are new items of Radio Transceiver Labs., Richmond Hill, N. Y. They weigh 35 pounds and, with self-contained batteries, develop 2 watts of carrier power. The units can operate on any frequency in the 30-40 Mc. region and other frequency ranges can be installed. Having 1½" German silver dials and a special dial locking device, these crystal controlled transmitters are similarly designed and differ only in oscillatory circuit and r-f amplifiers.



With special Hiperm alloy transformers with a substantially flat response from 40 to 10,000 cycles, the audio amplifier has been designed to work out of any low impedance dynamic, velocity or inductor microphone with output level of 90 db or higher. Crystal or other high impedance microphones may be used by "wiring out" the 30 to 250 ohm tapped input transformer provided.

Pee Wee Transmitter

A 25 WATT crystal controlled transmitter, supplied complete, in kit form for the amateur, is announced by General Transformer Corp., 1294 W. Van Buren St., Chicago. Both the power and the r-f portion are mounted on a single chassis. Working three bands with one crystal and five bands from 160 to 10 meters with two crystals, the unit forms a flexible exciter for a 100 watt stage when added power is desired. It can be used as an emergency transmitter and is portable.

Antenna Ammeters

REMOTE-READING antenna ammeters designed for a maximum of safety from failure due to lightning is announced by Victor J. Andrew, 7221 S. Francisco Ave., Chicago. Rugged construction and the use of a shielded current transformer with a vacuum tube rectifier insure reliability and accuracy.

FERROCART

Cores for permeability tuned push-button systems

1. Low frequency drift
2. Easy adjustment
3. Compact
4. Economical

May be supplied in various permeabilities for antenna, R.F. and oscillator coil tuning.

Systems using our standard grade AA in antenna coils may be tracked for 455 KC using our color-coded low μ oscillator cores with closely held tolerances of all permeability values.

Entirely dependable close electrical and physical tolerances and uniformity. Prompt deliveries of any large quantity of the above as well as of high "Q" or high permeability cores for antenna, R.F. and I.F. coils.

Many standard designs of screw cores, pot cores, etc.

Inquiries invited.

FERROCART
CORPORATION OF AMERICA
Hastings-on-Hudson, N. Y. U.S.A.

- For the past 15 years every major improvement in the electrical alloy art has been sponsored by Wilbur B. Driver.
- And in Tophet (pronounced top-fet) you are offered the sum total of the pioneer's experience, skill and good name.

WILBUR B. DRIVER CO.
NEWARK, NEW JERSEY



ELECTRONICS — June 1938

Aircraft Transmitter

LIGHT WEIGHT efficient, remote-controlled describes the new Learadio UT-6 Six-Frequency Aircraft Transmitter introduced by Lear Developments, Inc., Roosevelt Field, Mineolo, N. Y. Any one of six frequencies may be remotely selected. The total overall size is 14 in. long x 8½ wide x 8½ high and weighs 27 lbs. completely installed. The unit is both a 100% modulated phone transmitter and a 1000 cycle 100% modulated telegraph transmitter. Either type of emission is controlled from the re-



ote control panel. Normal output ranges between 20 and 30 watts depending on battery voltage and plate loading. Interphone communication is made possible by an additional jack provided on the panel.

Noise Suppression Condenser

"HASH" CONDENSER, Type 1122, for auto-radio is announced by Aerovox Corp., 70 Washington St., Brooklyn, N. Y. It is a metal can paper job with grounded bottom bracket and top terminal lug, intended for mounting and connections directly on the car generator. The standard capacity is .5 mfd. The voltage rating is 100, although the condenser is subjected to little over 6 volts in normal service.

Condensers

SEVERAL NEW UNITS are announced by Du Mont Electric Co., Inc., 514 Broadway, New York City. These include small tubular electrolytics and are known as Supercaps; a new low-loss mica condenser and a line noise filter.

Conductor Cable

LENZ ELECTRIC MFG. CO., 1751 N. Western Ave., Chicago, Ill., announces a high-Q, low capacity multiconductor cable for use in permeability tuned radio receivers. A new line of shielded cables for auto radio antenna leads having especially low capacity is also available.

Doolittle

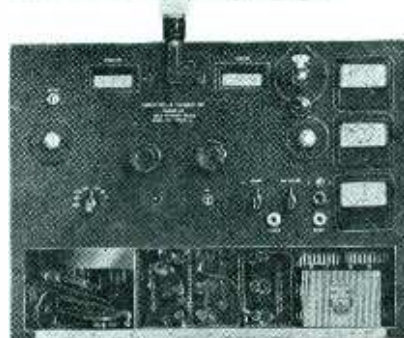

FIELD INTENSITY METER

THE Model RA Field Intensity Meter represents a long desired achievement. It fills the need for a precision instrument that is thoroughly reliable and efficient. The Model RA has been made compact and easily portable without sacrificing any of its outstanding operating characteristics. We will gladly send our bulletin, which describes the Model RA in detail, upon receipt of your request.



We offer you the services of a staff of Radio Transmission Engineers and Consultants who will make complete location and field intensity surveys as well as antenna resistance measurements and solutions of special design problems.



We are Manufacturing Engineers and can supply

1. Concentric Transmission Lines
 2. U H F Monitors
 3. Special Transmitters and Receivers
- and other radio transmitting equipment and supplies

There are some territories in which we need representatives.
WRITE FOR DETAILS



DOOLITTLE
and
FALKNOR INC.

7421 S. LOOMIS BLVD., CHICAGO, ILL.

NEW INDUSTRIAL SOCKET-

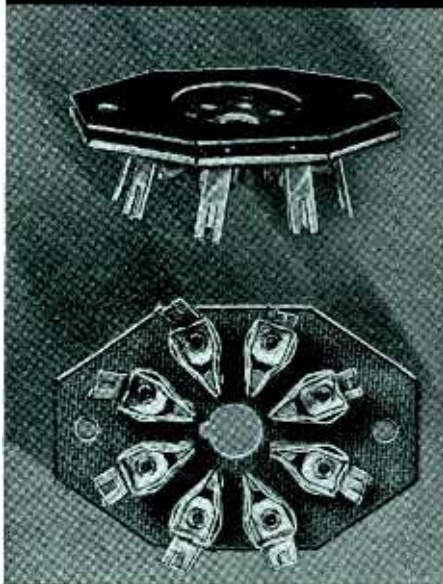

THIS new Hammarlund "Industrial Socket" embodies constructional features heretofore found only in the most expensive ceramic type. Heavy duty contact design makes this unit ideal for industrial applications. In sound equipment where constant tube replacement causes socket failures, engineers will find this socket an outstanding improvement. It will eliminate annoying program interruptions and reduce servicing costs.

Featuring two-piece construction, this new socket is made of low loss natural color bakelized canvas. Contacts are made of heavy non-corrosive metal reinforced with steel clamps to insure positive electrical contact over a long period of time and through a great number of tube changes.

Use this improved socket in your new equipment and be assured of satisfied customers. Write for details.

SEND FOR CATALOG!

HAMMARLUND MFG. CO., INC. E-6
424-438 West 33rd St., N. Y. City

Please send me "38" catalog.

Name

Address

City State



Loud Speakers

HIGH EFFICIENCY 12 in. Nokoil, in three types, according to frequency range covered, by Wright DeCoster, Inc., St. Paul, Minn. Low frequency type covers 50 to 3500 c.p.s., standard type covers from 60 to 5000 c.p.s., and the wide range from 60 to 7500.

Mica Capacitors

TYPE 86 MICA condensers incased in ceramic material are available for amateur transmitter purposes from Cornell Dubilier Electric Corp., South Plainfield, N. J. Through the use of mica the advantages of low power loss and constant capacity are secured.

Amateur Equipment

NEW NATIONAL Company, Inc., Malden, Mass., apparatus shown at the Chicago Trade Show included an "S" meter to replace the magic eye of popular national receivers; a new calibrated dial and direct reading vernier giving band spread readings to one part in one

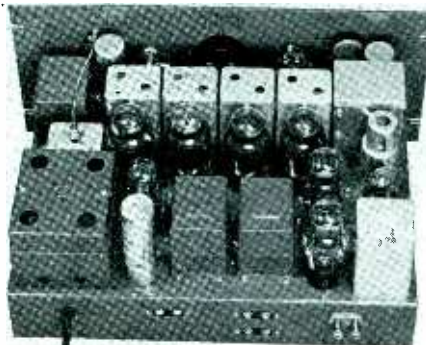

thousand; a speech amplifier and all band crystal controlled exciter mounted in one self-contained unit, complete with power supply, known as NTE; and Foundation units which make possible compact and easy assembly of 600 watt amateur transmitters.

Frequency Standard

THREE CRYSTAL controlled oscillators operating at 100, 1000 and 10,000 kc. generating useful harmonics up to the 30th and 40th of each crystal fundamental are contained in small portable, economical frequency standard developed by the Ferris Instrument Corp., Boonton, N. J. By means of a multi-vibrator harmonics up to 3000 kc provide finer frequency intervals. Crystals are ground and adjusted to an accuracy of 100 cycles per megacycle. Total possible error under normal would not exceed .02 per cent.

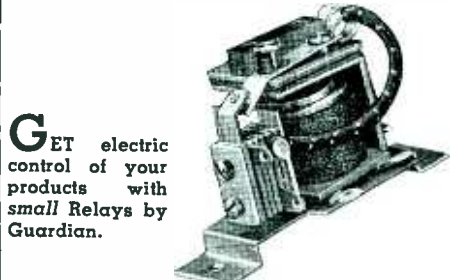

GET electric control of your products with small Relays by Guardian.

Easy to install in very small space. Model shown No. 150 AC is only one of several types. These small Relays do a BIG JOB as well—even better—than larger, more costly controls. Maximum size, with double throw, double pole contacts, 2 1/4 x 1 3/4 x 1 9/16" high.

Money savers in quantity production... long lasting—usually outliving the product itself. You can get THOUSANDS of varieties of Relays by Guardian as FAST as you want them.

Write today

Give voltage, amperage, contact capacity and contact combinations for the application you have in mind. If general information is wanted, write for catalog E.

GUARDIAN G ELECTRIC
1625 W. WALNUT STREET CHICAGO, ILLINOIS

COMPLETE A. C. ELECTRIC PLANTS



Compact • Lightweight • Portable

A.C. ELECTRIC PLANTS—many Models supply both A.C. and D.C. output at any voltage. Accurate voltage and frequency regulation—Ideal for operating RADIO TRANSMITTERS—RECEIVERS—FURNISHING POWER for TESTING of INSTRUMENTS and APPLIANCES away from power line—STANDBY for EMERGENCIES when power service is interrupted. Installed in Trucks—Trailers—Passenger Cars for Public Address Service, Advertising, Testing, Demonstrating. All Models operate ECONOMICALLY ON GASOLINE. Standard 110 volt A.C. and COMBINATION A.C.-D.C. Units in all sizes from 350 to 5000 watts capacity can be shipped from stock. Special voltages and capacities shipped promptly. Complete details on request.

D. W. ONAN & SONS
362 Royalston Ave. Minneapolis, Minn.

Sapphire Needles

NON-INJURIOUS TO ACETATE records, full range tone quality, and freedom from needle changing in transcription use because of the ability to play 2000 records are claimed for the Walco sapphire phonograph needles, a product of Electrovox Co., 424 Madison Avenue, New York. Price is \$2 per needle.

Mercury Relay

KNOWN AS VERTEX, a non-tilting, vertical, mercury relay is obtainable from Dr. F. Loewenberg, 10 East 40th St., New York City. All mechanical moving parts are sealed in glass and thereby it is claimed to have more reliability and efficiency in operation and requires less space than similar mercury switches.

Relays

FEATURING a completely sealed contact chamber, Allied Control Co., Inc., 95 Liberty St., New York City, has designed Bakelite housed relays for low current consumption. The entire assem-



bly occupies 2 1/4 in. space. The mechanism is a quick acting solenoid plunger. The contactor section is a hermetically sealed switch.

Overload Relay

STRUTHERS DUNN, Inc., 139 N. Juniper St. Philadelphia, have developed a new relay available for use on either a-c or d-c currents. The contacts are rated 30 amp. at 110 volts d-c and 3 amp. at 230 volts d-c on non-inductive loads. The contacts can be arranged to be closed manually or by means of a voltage operated coil and when closed, they latch close. The latch is adjusted to pick up and open the contacts when the current in the overload coil reaches the proper value. This setting is adjustable by means of the knurled nut on top of the relay over a range of 2 to 1.

ELECTRONICS — June 1938

PROVEN!

The Du Mont Type 168 Five Inch All Purpose CATHODE RAY OSCILLOGRAPH



Thru faithful every day service in the Industrial and Educational laboratories of the world this popular priced Du Mont five-inch oscillograph has proved to be an indispensable piece of apparatus. Light, compact yet rugged, it incorporates all the desired features of a general purpose oscillograph. Its flexible operation plus the highly desirable features of a five-inch cathode ray tube make this instrument the greatest value in necessary laboratory apparatus.

Price and complete specifications on request.

ALLEN B. DU MONT LABORATORIES, INC.
PASSAIC NEW JERSEY

Cable Address, Wespexlin, New York

Your Product can be Improved with

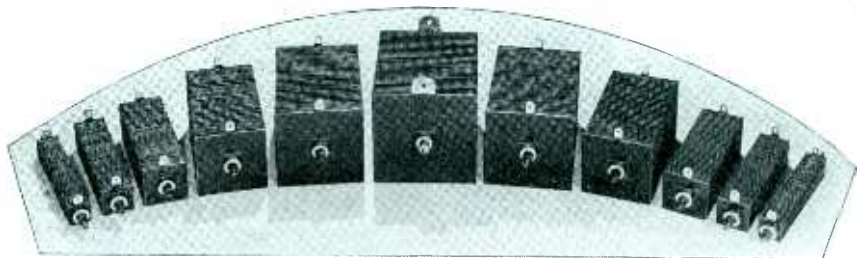

B-L RECTIFIERS

New Designs • Higher Outputs • Lower Costs

These are a few new additions to the already large family of B-L Rectifiers. Used singly and in combination, they cover a wide range of capacities from a fraction of an ampere to a hundred or more, and voltages of a corresponding order.

B-L Dry Metallic Rectifier Units are compact, rugged, and dependable. They are not easily damaged by severe overloads or by high temperatures.

Units are full wave bridge type, and are available for operation on three phase as well as single phase supply circuits.

Typical applications include:

| | |
|---------------------------|---------------------|
| Electronic Tube Filaments | Small Motors |
| Relays and Contactors | Vibrating Devices |
| Exciter Lamps | Magnetic Controls |
| Dynamic Speakers | Pilot Lamps |
| Battery Chargers | Battery Eliminators |
| Telephone Equipment | Signal Systems |

B-L specializes in rectifiers and complete power units, both filtered and unfiltered. Write today for further information and price quotations, addressing our Electronic Applications Department. Our engineers will be glad to cooperate. No obligation, of course.

The B-L ELECTRIC MFG. CO., St. Louis, Mo.

REMLER ATTENUATORS

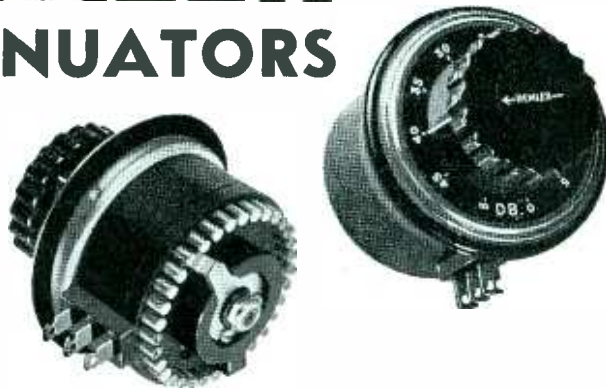

**BALL BEARING
ROTOR SHAFT**

**CLOCK SPRING
PIGTAIL
CONNECTION**

LA-5 Ladder
Type—Net

\$10.80

DLA Type, silver
contacts \$12.80

New improvements, unequalled ease of operation and long life! Attenuation variable in 27 steps of $1\frac{2}{3}$ db. per step up to 45 db. fading in 3 additional increasing steps from 45 db. to infinity. A single sliding contact in the input circuit results in contact noise being attenuated within the unit in direct proportion to the loss introduced in the circuit, providing a constant signal-to-noise ratio. Impedance practically constant over entire range of the pad. Standard impedances of 50, 200, 250 and 500 ohms. Special values to order.

Remler Company, Ltd., 19th at Bryant,
San Francisco

REMLER—THE RADIO FIRM AS OLD AS RADIO

McGraw-Hill
DIRECT MAIL LISTS



As business paper publishers for over fifty years, McGraw-Hill is uniquely equipped to offer complete, authoritative direct mail coverage of Industry's major markets. Extreme accuracy is maintained (guaranteed to 98%) and through careful analysis of markets, complete classification of companies and personnel, etc., the widest possible selections are available. Send for handy reference folder, "Hundreds of Thousands of Reasons Why" which describes how McGraw-Hill Lists are built and maintained.

What Fields Do You Want to Reach?

Aviation
Bus & Electric Railways
Civil Engineering and Construction
Administrative Executives

Electrical Dealers & Wholesalers
Mill Supply Houses
Power Services
Product Engineering & Design
Production and Maintenance
Radio Dealers & Wholesalers
Radio Engineering & Design

For further details, selections from above basic classifications, counts, prices, etc., or estimates on special lists . . . ask any representative or write to



Complete Lists Covering Industry's Major Markets

Heavy Duty, Hi-Power Genemotors



400 Volt, 200 Mil.
(Motor Only, 7" x 4" x 2 7/8" - Weight 10 lbs.)

For Hi-Gain Amplifiers, Ultra Short Wave Two-Way Police Radios, Aircraft Radios, etc. Six years of successful performance.

There is a Carter Genemotor for every requirement.

SMALL SIZE—NO HASH
LIGHT WEIGHT—RELIABLE
Write for Complete Information

CARTER MOTOR CO.

1608 MILWAUKEE AVE.

CHICAGO, ILL.

PA Unit

REMOTE VOLUME control features Model 414 Operadio portable 14 watt public address unit. The volume can be adjusted from any point in the audience without moving, or going to the amplifier. The circuits utilize beam power tubes with cathode degeneration, 12 in. heavy-duty permanent speakers. Provision for head phone and meter monitoring. Operadio Mfg. Co., St. Charles, Ill.

Amplifier and Centralized Sound System

MODEL CX70 BINAURAL amplifier features auditory perspective reproduction. The unit is composed of two amplifiers with dual channels throughout. Each of the two output stages deliver 35 watts of power with less than 4% distortion, and may be operated separately or simultaneously, or one channel may be run at high volume level for outdoor speakers while the other channel operates at lower level for indoor speaker. Six input channels, 4 microphones, 2 for phono pickup, and all mike channels may be used at the same time. The unit contains 17 tubes with four 6L6's in the output channel.

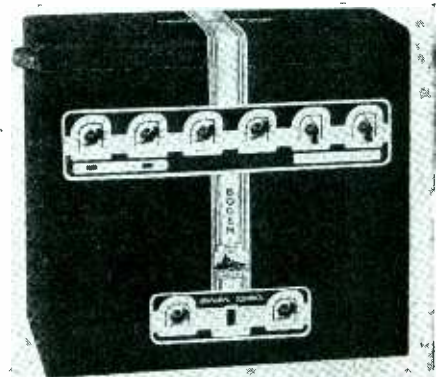

MODEL S-32 for use in schools, institutions, hospitals, etc., is a new centralized sound system which includes a great number of features including provision for up to 32 classroom switches and talk-back features. Both are new products of David Bogen Co., 663 Broadway, New York City.

Exposure Meter

A NEW PHOTOELECTRIC photographic exposure meter is distributed by Intercontinental Marketing Corp., 8 W. 40th St., New York City. This unit is very compact and can be strapped to the wrist. The essential element is an electro-cell which is coupled to a sensitive instrument and according to the manufacturer has sufficient sensitivity to give a distinct reading at a light level so low as to require 30 seconds exposure at F/11 and 23 Scheiner.

PROFESSIONAL SERVICES

Rates on Application

ELECTRICAL TESTING LABORATORIES

Characteristics and Life Tests of Vacuum Tubes
Tests of photo cells, glow lamps, crater lamps.
Tests of electronic and optical devices.
30th Street and East End Avenue
New York, N. Y.
Phone: Butterfield 8-2600

THAD. R. GOLDSBOROUGH

REGISTERED PATENT ATTORNEY
Former Manager Patent Dept. RCA Manufacturing Company.
201-205 McLachlen Building
WASHINGTON, D.C.

INTERNATIONAL ELECTRONICS, INC.

AMERICAN CONSULTING ENGINEERS TO FOREIGN MANUFACTURERS
Designs Specifications
Electrolytics Tubes Resistors
Transmitters Receivers
630 Fifth Avenue New York, N. Y.
Cable:—Interengin, New York

HAROLD J. McCREARY

Mem. A.I.E.E. & W.S.E.
Consulting Engineer
Research Electronics
Development Television
Design Radio
Factory Practise Railroad Signaling
Patent Studies Telephony
105 W. Adams St. Phone STAt 4003 Chicago, Ill.

RADIO DEVELOPMENT & RESEARCH CORP.

CONSULTANTS AND DESIGNERS
including
Amplifiers—Antennas—Transmitters
Receivers—Laboratory Equipment
Special equipment designed and constructed
145 West 45th Street, New York, N. Y.
Tel. BRyant 9-6898

PROFESSIONAL ASSISTANCE

in the solving of your most difficult problems in the highly specialized field of electronic devices is offered by consultants whose cards appear on this page.

Oscillograph

A MODIFICATION of a previous type 168 five in. cathode-ray oscillograph is announced by Allen B. Du Mont Labs., Inc., Passaic, N. J. This new type 171 has 3 additional controls provided for a beam switch, a grid amplifier, a single sweep feature and symmetrical horizontal reflection. These features lend themselves to the study of transients and demonstration of television principles.

Molding Compound

A NEW MOLDING compound, known as 2274, announced by the General Plastics, Inc., North Tonawanda, N. Y., was developed to meet the problem of molding parts with especially large inserts which are subject to extremes of temperature. The final set is somewhat more flexible than with similar materials, thus avoiding cracking. It is adaptable with terminal studs, brush holders, etc.

Counting Control Unit

A NEW TYPE of photo-electric counter unit with a standard mill type lamp which eliminates expensive light source, focusing adjustments, and lamp renewals, has been announced by the Wayne

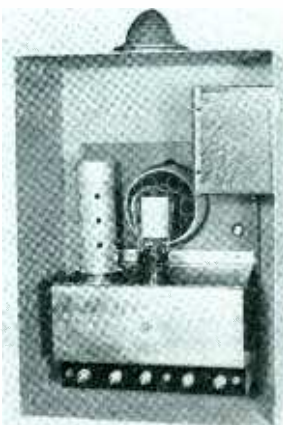

Automatic Relay Co., Fort Wayne, Ind. The self-contained unit has an ingenious light louver system to keep out all extraneous lights, and a corrected condensing lens to direct the full light energy upon the phototube. An amber light signals each step of the counter cylinder thereby protecting against non-operation or malicious tampering. A 3/4 in. separation of parts being counted serves to actuate the counter unit, operating on 110 volts a-c or d-c current supply.

Record Player

A RECORD-PLAYER instrument for use with electrically operated radio receivers has been introduced by Radio Corp. of America, Camden, N. J.



POWER LEVEL INDICATOR Built Standard or to SPECIAL REQUIREMENTS



POWER LEVEL INDICATORS

Model 421—4" Instrument.....\$13.17
Model 321—3" Instrument.....\$12.00

Triplet Decibel Meters conform to Triplet precision standards of accuracy within 2%. The standard range furnished reads up 6 and down 10 decibels, zero decibel at 1.73 volts, 500 ohm line, 6 milliwatts. Decibel Meters are standard damped or highly damped at regular prices. Just specify on order. Quotations gladly furnished on special calibrations.

DECIBEL METER KIT

Triplet supplies also Decibel Meter Kits for non-constant impedance. Model 150 Decibel Meter Kit includes Triplet Model 321 Decibel Meter, Selector Switch, 9 Wire-wound Multipliers on Bakelite Mounting Board, Hook-up Wire, Diagrams and Instructions. Net Price...\$20.00.

SEE THE NEW TRIPLET 1938-39 LINE AT THE CHICAGO JUNE RADIO PARTS SHOW BOOTH 213-15 HENRY AVE.



The Triplet Electrical Instrument Co.
236 Harmon Dr., Bluffton, Ohio
Please send me more information on

- Triplet Decibel Meters
 Decibel Meter Kits

Name

Address

City State

Sensitive at Front —Dead at Rear!

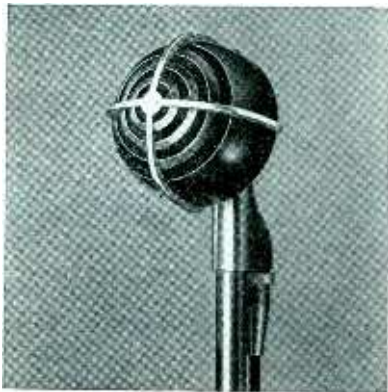

New Shure UNIPLEX True Uni-Directional Crystal Microphone

New principle (*pat. app. for*) makes true uni-directional operation possible for the first time at low cost. Solves feedback, room and background noise, reverberation problems. High quality, wide-range front-side response—down 15 db at the rear. Beautiful, modern “speed-line” design, with tilting head. New integral connector receptacle. Polarized locking-plug permits instant cable disconnection. *Write for new catalog—today!*

Model 730A “UNIPLEX.” List Price, complete with 25 ft. cable and connector-plug **\$29.50**

New Economy Pickup

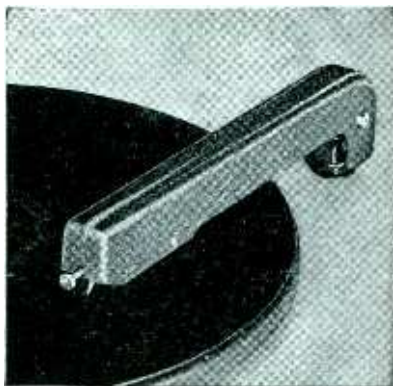

A small, compact crystal pickup with Shure needle-tilt balanced-tracking. Full-range frequency response. Triple-moisture-proofed Grafoil Bimorph crystal. Floating, rubber-cushioned pivot-bearing assembly, designed for single-hole motorboard mounting. Sturdy, cast arm in modern “Speed-Line” design.

Model 94A. Complete with arm rest, List Price **\$6.50**

Shure Patents Pending. Licensed under patents of the Brush Developing Company.



Recording Material

A NEW INSTANTANEOUS recording material known as “Audiodiscs” is being put out by Audio Devices, Inc., 1600 Broadway, New York City. The characteristics are low surface noise and long playing life. Audiodiscs are claimed by the manufacturer to be uniform and do not deteriorate with age.

Motor-Driven Push Button Unit

FAST TUNING, completing a 180° turn in one second is claimed for the new tuning unit announced by Utah Co., 820 Orleans St., Chicago, Ill. Simple setting is accomplished by pushing in the desired button and tuning the station manually, from the front of the cabinet. Overall dimensions are 3½ in. x 2¾ in. x 2 in., making automatic

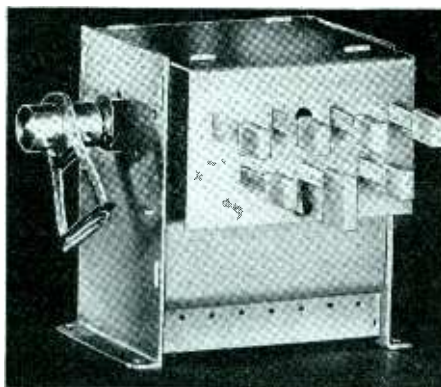

push button available for small table model sets. A midget motor provides the motive power and assures accuracy, while the electrical circuit is controlled by a single set of contacts using a single wire. Drift within the unit itself is impossible, according to the manufacturer.

Tubular Condenser

A CERAMIC-CASED tubular condenser offering greater insulation both electrically and against moisture is a new item of Girard-Hopkins, 1437 23rd Ave., Oakland, Cal. The condensers are rated with high safety for 600 volts d-c working voltage and in capacities from .00025 to 1. µf, and are non-inductively paper wound.

Metal Clad Resistors

RESISTANCE WIRE-WOUND on a special heat resisting Bakelite core, permanently imbedded in moisture-proof Bakelite, incased in a metal jacket describes new fixed resistors offered by Clarostat Mfg. Co., Inc., 285-7 North 6th St., Brooklyn, N. Y. Series MPT units measure 1½ in. by ½ in. x 1/8 in. Dissipate 3 watts and come in values from 10 to 10,000 ohms.

NEW BOOKS

The Low Voltage Cathode Ray Tube

By G. PARR, Radio Division, Edison Swan Electric Co., Chapman and Hall, Ltd., London, 1937. American distributor, Allen B. DuMont Laboratories, Upper Montclair, N. J. Price \$4.00, 177 pages, 76 illustrations.

THIS ADDITION to the literature on cathode-ray methods is welcome principally for the reason that it contains three chapters on the applications of C-R tubes, a topic largely neglected in other books. It is written from the British point of view, and devotes considerable space to the gas-focussed type of tube which is now virtually unknown in America, but otherwise the book is well suited to the American reader. The table of representative tubes contains American as well as British types.

The theoretical discussion of the C-R tube is limited to the equations governing magnetostatic and electrostatic deflection. The electron gun theory is not treated, apparently because it is of no direct interest to the user of the tube. A good chapter on Lissajous' figures, and one on linear sweep circuits are included. The sections on applications include those in radio engineering, in industrial pursuits, and in C-R television.

The Radio Antenna Handbook

By the Technical staff of RADIO

Published by Radio, Ltd., 7460 Beverly Blvd., Los Angeles, Calif. Stiff paper cover, 112 pages, 6 in. by 9 in. Price, 75 cents in continental U. S. A.; elsewhere, 85 cents.

IN THIS COMPILATION of antenna data, emphasis is laid upon practical aspects, though theoretical considerations are not slighted. It covers the whole antenna problem for the amateur and others using the high frequencies. Tables, graphs, diagrams, and charts throughout the book enable one to avoid involved computation and calculation in design problems.

The great amount of interest currently exhibited in directive antennas is acknowledged by approximately 40 pages dealing with virtually every directive antenna of practical value, including the very latest types of close-spaced arrays.

The book should enable any novice to ascertain the most practical antenna installation for his particular requirements, and to design and effect the installation with a minimum of effort. From this standpoint it is of value to the advanced amateur or engineer.

U. S. PATENTS

Electron Tube Applications

Remote metering system. Several remote d-c indicating instruments are actuated in accordance with variable quantities of a.c. by means of amplifier tubes. H. L. Bernarde, W.E.&M. Co. No. 2,106,825.

Acroronograph. The use of a tube with a welding circuit whereby the tube indicates the relative durations of the fusing stage and the transfer stage. Bela Ronay, Annapolis, Md. No. 2,106,190.

Textile control apparatus. A method of detecting a bowed condition of the weft members of a strip of woven material by means of several photo-electric tubes. C. W. La Pierre, G.E. Co. No. 2,106,611.

Timing circuit. Use of vacuum tube for timing the periods during which a work-circuit is closed and open. D. C. Wright, The Electric Controller & Mfg. Co. No. 2,105,899.

Control system. A vacuum tube system operating in response to a change in a condition such as the speed of a motor. K. H. Hubbard, Taylor Instrument Companies. No. 2,105,598.

"PLUG-IN" ANTENNA

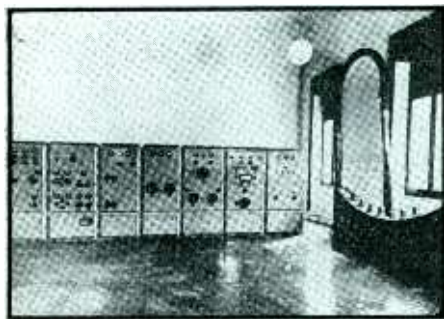

The new short-wave transmitter at Vatican City makes use of an unusual antenna-switching arrangement (right, above). A flexible coaxial cable, connected to the transmitter output, may be attached to any of seven outgoing cables to different antennas designed for use on various wavelengths and possessing different directional properties

Moving stairway. Use of a photo-electric tube to control the speed of a conveyor. W. F. Eames, Westinghouse E&M Co. No. 2,106,833.

Electron tube circuits. The following patents have been granted to the Westinghouse Co.: No. 2,096,427, thy-

atron tube controlled by a light sensitive tube. Light relay circuit using a voltage doubler, a three grid tube, photo tube, etc. B. E. Lenehan, No. 2,075,120. Coil winding—a machine for winding filamentary wire into helices for incandescent lamps and an electronic means of stopping the machine if the helices are not formed for an appreciable portion of time, G. C. Holloway, No. 2,076,236. Regulating system—tube apparatus for use on a-c dynamo-electric machine, No. 2,083,297. Welding apparatus—No. 2,083,190, J. W. Dawson. Control system—A primary electro-responsive device having a movable element directly responsive to an electrical condition which effects variations of an impedance characteristic, H. L. Bernarde, No. 2,075,083. Bridge system—a circuit for use with a triode and a four-armed network of bridge type, F. W. Lyle, No. 2,042,234. Signaling system—means for sending light polarized in a selected plane, an analyzer, etc., L. W. Chubb, No. 2,075,094. Voltage regulator—in combination with a rectifier interconnecting an a-c circuit with a d-c circuit, an inductance and capacitance having values near resonance for the desired current value in d-c circuit, C. V. Aggers. No. 2,085,061. Lathe control—apparatus for shaping a work piece into an object having a predetermined cross-section by means of a light-sensitive device, H. P. Sparkes, No. 2,085,127. Paper dryness control—a valve for controlling the rate of admission of the drying medium to the drier elements with a tube control, No. 2,085,128. Stroboscope—apparatus for observing a body in periodic motion, No. 2,085,100. D. D. Knowles. Elevator control, No. 2,085,133, E. H. Vedder. Temperature control system, No. 2,088,477, D. D. Knowles. Split-cycle timing device, J. F. Kovalsky, No. 2,088,478. Light sensitive system—compensating apparatus for a system comprising several tubes, several impedances, the magnitude of which may be varied, and means by which a rise in impedance in one portion of the circuit is counterbalanced by a decrease in impedance in another portion of the circuit, Hymen Diamond, No. 2,088,466. Cathode ray system—apparatus for producing a radiant energy display, L. E. Swedlund, No. 2,088,495. Grid glow tube circuits—No. 2,088,494, L. E. Swedlund.

Coin tester. Method of distinguishing between genuine coins, tokens, etc., and spurious articles by producing an electric discharge having a spectrum characteristic of the material of the article to be tested which is then examined by a light-sensitive device. H. L. Petterson, to Patentaktiebolaget Ambia, Stockholm, Sweden. No. 2,100,977.



QUALITY!



THERE'S nothing old-fashioned about Stancor design or appearance—for modern engineering has kept Stancor Transformers in step with every modern development.

But Stancor still insists on the old-fashioned idea that "good enough" is not good enough. You can depend on Stancor to be enough better than the letter of the specification to provide a safe margin of performance ability.

Stancors compete with all comers in terms of what you get for your dollar.

**STANDARD
TRANSFORMER
CORPORATION**

1500 NORTH HALSTED STREET • CHICAGO

QUALITY

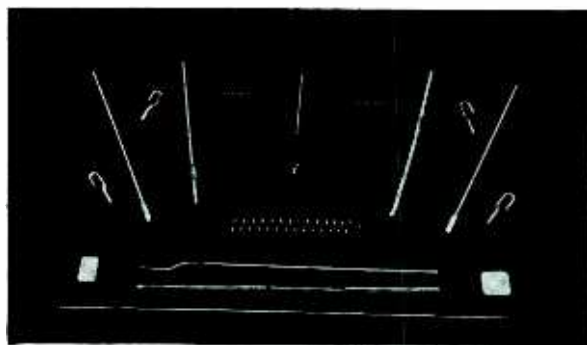

WHATEVER your specific requirement, CALLITE Tungsten and Molybdenum wire, rod and sheet have tested and dependable quality. Many special shapes or formed parts can be made to your exact specifications. Let our consultants aid you in your problem on cathodes, lead-in wires, filaments, plates, grids, spring hooks and other parts for power tubes. Be assured of uniform quality by specifying CALLITE wherever Tungsten and Molybdenum are used.

CALLITE

TUNGSTEN • MOLYBDENUM

Callite Products Division, 544-39th St., Union City, N. J.

British Patents

Automatic volume control. The grid bias of an amplifier is controlled so that it is approximately the same for zero and normal signal amplitude and is a monotonic function of the amplitude over a substantial range including the normal amplitude. Siemens & Halske. No. 465,742.

Automatic tuning. To overcome the tendency of the A.F.C. of a radio receiver to overshoot to an appreciable extent the true center frequency, the characteristic curve which relates oscillator frequency change to grid volts change of the tuning tube is made closely to follow the curve relating control voltage and frequency off resonance of the control system. E. K. Cole. No. 465,827.

Automatic gain control. Resistance units of silver sulphide having a high negative temperature coefficient of resistance are used to control the gain of an amplifier automatically in dependence on received signals or to compensate for variations in the resistance of transmission lines. Standard Telephones & Cables. No. 465,923.

Superheterodyne. The local oscillator is inoperative except when tuned accurately to the input signal. Marconi Co. No. 466,854.

PERFORATION CHECKER

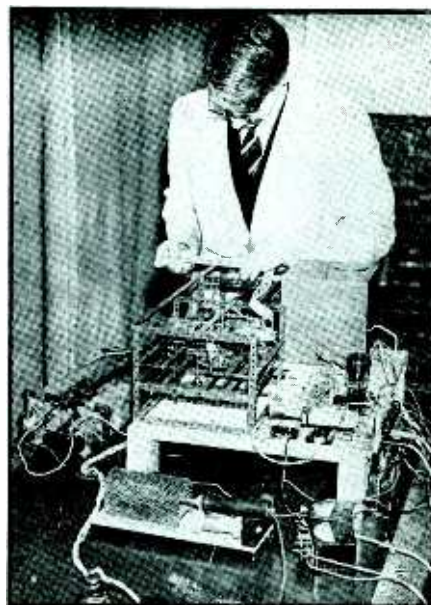

Engineers of the British Post Office have developed this photoelectric perforation checker, which measures the width of the holes in relation to the paper "bridges" between, to within a few thousandths of an inch. Incorrect perforations result in tearing stamps taken from slot machines

MOLDED RESISTORS

S.S. White
The "All-Weather" Resistors

AMONG THE USERS

Radio Corporation of America
RCA Manufacturing Co., Inc.
RCA Communications, Inc.
General Electric Co.
Westinghouse Elec. & Mfg. Co.
Automatic Electric Co., Ltd.
Bartol Research Foundation,
Franklin Institute
R. S. Hart — Moisture Gauge
Merck Institute of Therapeutic
Research
National Technical Laboratories
Roller-Smith Company
General Talking Pictures Corp.
National Broadcasting Co.
Pan American Airways, Inc.
Railway & Industrial Engineering Co.
Webster Electric Co.
Audio Research, Inc.
U. S. Army and Navy
Griffith Observatory

... 1,000 OHMS TO
1,000,000 MEGOHMS

Full details and illustrations in
RESISTOR BULLETIN 37
Free copy with Price List sent
on request. WRITE for it.

NOISE TESTED

At slight additional cost, resistors will be supplied individually "noise-tested" to this specification: "For the complete audio frequency range, resistors shall have less noise than corresponds to 1 part in 1,000,000." (For values up to 10 megohms)

S. S. WHITE

The S. S. White Dental Mfg. Co.
INDUSTRIAL DIVISION

10 East 40th Street, Room 2310E, New York, N. Y.

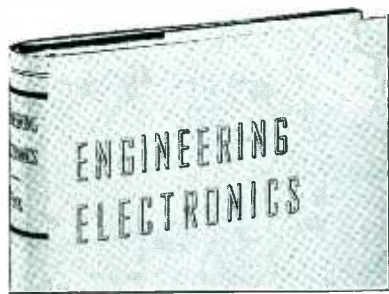

Bringing engineers up to date on current electronic engineering practice

HERE is a new book to meet the engineer's need for a working introduction to electron tubes and the design of circuits for their application. In a practical treatment it brings you the information you need to understand the present status of electronic science, to handle its engineering applications, to keep abreast of progress and meet the increasing demands and opportunities in this field.

Just Published ENGINEERING ELECTRONICS

By Donald G. Fink

Managing Editor, *Electronics*

358 pages, 6 x 9, 217 illustrations, \$3.50

THIS book presents a quantitative treatment of electronic engineering, on a level commensurate with the engineer's average use of mathematics and physics and correlated with general electrical engineering practice.

This book gives you:

- an introductory working knowledge of electron physics; the electron, its properties, methods of production in the free state, control by electric and magnetic forces, etc.
- an understanding of practically all modern types of electron tubes, their construction, principles of operation, and characteristics
- a working knowledge of the application of these characteristics to electronic circuit design
- an understanding of many practical applications of electronic circuits

In addition to the standard electron tube structures and their uses, a large number of special types such as electron multipliers, electron microscopes and telescopes, electron image tubes, television tubes, etc., are covered.

The circuits described and illustrated have to do with power transformation, electrical communication, and industrial control and measurement problems.

10 days' examination — Send this coupon

McGraw-Hill ON-APPROVAL COUPON
McGraw-Hill Book Company Inc.
330 W. 42nd St., New York, N. Y.

Send me Fink's Engineering Electronics for 10 days' examination on approval. In 10 days I will send \$3.50, plus few cents' postage, or return book, post-paid. (Postage paid on orders accompanied by remittance.)

Name

Address

City and State

Position

Company L. 6-38
(Books sent on approval in U. S. and Canada only.)

ELECTRONICS — June 1938

Quartz crystals. A crystal is cut so that its principal surface is inclined at an oblique angle of 37 deg. to 40 deg. to the optic axis and parallel to an electric axis, and its length and

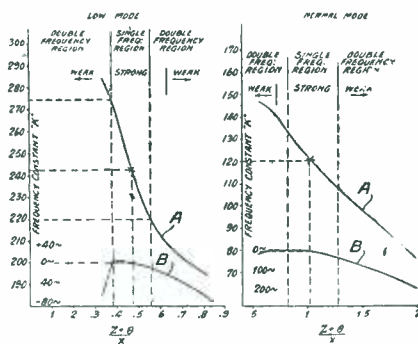

width are proportioned so as to render the crystal capable of oscillating at one frequency only in its electric axis mode of vibration. If the desired frequency is f and x is the dimension in the electric axis, $fx = k$ where k is a constant determined from the curves shown. Marconi Co. No. 464,894.

High gain tube. Means for increasing the mutual conductance of a tube by utilizing an aperture anode and, on the far side of the anode from the cathode, an electrode which is connected with a screening grid so as to be at the same potential, and has a surface emitting secondary electrons which pass to the anode. Philips. No. 466,929.

ARC-BACK SUPPRESSOR TUBE



This unusually shaped tube is a grid-controlled mercury rectifier used in the short-wave transmitter at Madras, British India. The lowest of the three bulbs is the mercury reservoir and hot cathode, the upper the anode chamber. The large bulb between them is the arc-back chamber. An internal graphite coating acts as a grid

Real Tube Economy

1000 watts at only \$250!

TYPE 1554 GAMMATRON (AIR-COOLED)

FCC ratings for broadcast use, 1000 watts high-level, 250 watts linear amplifier or low level

Plate voltage, 3000 volts
Plate dissipation 750 watts

Priced net, F. O. B. South San Francisco, Calif.
FURTHER INFORMATION QUARLY SUPPLIED

HEINTZ AND KAUFMAN LTD.
SOUTH SAN FRANCISCO CALIFORNIA U.S.A.

Model T-3 Microphone Being Shown at the Chicago Show

Highly praised for flexibility and performance. Unique tilting mount permits directional or non-directional position. Complete with interchangeable plug and socket connector. Chrome finish. Full year guarantee.
List Price \$25.00



Astatic Microphone Laboratory, Inc.
DEPT. A-2, YOUNGSTOWN, OHIO
Licensed Under Brush Development Co. Patents

A NEW PRODUCT!

ANACONDA ELECTRO-DEPOSITED

Pure Copper Sheets

Stock widths 30" or 60" . . . and in rolls of long lengths.
Thicknesses—1 ounce per square foot to 5 ounces per
square foot (approximately .0015 inches to .007 inches).

NON-POROUS . . . RUST-PROOF

Practical uses for Anaconda "Electro-Sheet" Copper in
new fields are innumerable. *Samples upon request.*

THE AMERICAN BRASS COMPANY

Department "D4"



Waterbury, Conn.

38231A

SIGMA RELAYS

Type 2-A—a single pole, double
throw instrument to handle 150
watts non-inductive load at 110
volts A.C. with field input of 12
milliwatts D.C. Field resistances
of 50 to 8000 ohms. Dust proof
case with standard five prong base
for plug-in mounting.



Type 2-B—operates at 4 milliwatts
D.C. to handle 50 watts non-induc-
tive load at 110 volts A.C. Me-
chanical features same as those of
the Type 2-A except for the
lighter hairspring. Plug-in mount-
ing. Field resistances 50 to 8000
ohms.

SIGMA INSTRUMENTS, INC.
388 TRAPELO ROAD
BELMONT, MASSACHUSETTS

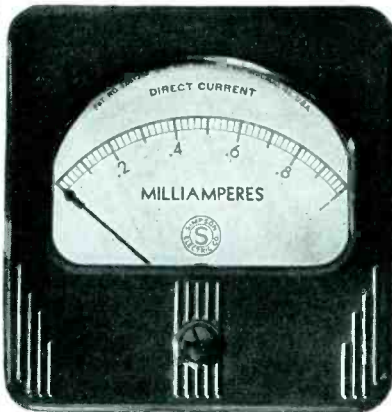

NEW BULLETIN covers ten models

● Engineers looked and saw. They saw a new
measure of panel instrument value in these Simp-
son Instruments—bridge-type construction and soft
iron pole pieces without the higher price such
instruments usually command.

As a result a long list of manufacturers have now
standardized on them as original built-in equip-
ment and for shop testing. The instrument above
is only one of ten models with handsome, modern
cases—both round and square—all described in a
new bulletin.

Ask for it—know the workmanship, quality, accu-
racy and value that is making instrument history.
The Simpson line also includes the finest radio
testing instruments.

SIMPSON ELECTRIC COMPANY
5218 W. Kinzie Street, Chicago, Ill.

SIMPSON

Instruments that STAY accurate

I. R. E. Program

[Continued from page 26]

SATURDAY, JUNE 18

9:00 A.M.

Exhibition opens.

10:30 A.M.—12:30 P.M.—Ballroom

"Radiotelephone System for Harbor
and Coastal Service", by C. N. Ander-
son, and H. M. Pruden, Bell Telephone
Laboratories, Inc., New York, N. Y.

"A Vogad for Radiotelephone Cir-
cuits", by S. B. Wright, S. Doba, and
A. C. Dickieson, Bell Telephone Labora-
tories, Inc., New York, N. Y.

"Ship Equipment for Harbor and
Coastal Radiotelephone Service" by
R. S. Bair, Bell Telephone Laboratories,
Inc., New York, N. Y.

"Remotely Controlled Receiver for
Radiotelephone Systems", by H. B.
Fischer, Bell Telephone Laboratories,
Inc., New York, N. Y.

"Coastal and Harbor Ship Radiotele-
phone Service from Norfolk, Virginia",
by W. M. Swingle, The Chesapeake and
Potomac Telephone Company, Norfolk,
Va., and A. Bailey, American Telephone
and Telegraph Company, New York,
N. Y.

10:30 A.M.—12:30 P.M.—Parlor I

"Deviations of Short Radio Waves
from the London-New York Great-
Circle Path", by C. B. Feldman, Bell
Telephone Laboratories, Inc., New York,
N. Y. (Demonstration.)

"The Application of Maximum-
Usable-Frequency Graphs to Com-
munication Problems", by N. Smith,
S. S. Kirby, and T. R. Gilliland, National
Bureau of Standards, Washing-
ton, D. C.

"Factors Affecting the Selection of a
Radio Broadcasting Transmitter Loca-
tion", by W. B. Lodge, Columbia Broad-
casting System, Inc., New York, N. Y.

"The Effects of Ionosphere Storms
on Radio Transmission", by S. S. Kirby,
N. Smith, and T. R. Gilliland, National
Bureau of Standards, Washington, D. C.

"A Study of Ultra-High-Frequency
Wide-Band Propagation Characteris-
tics", by R. W. George, RCA Communi-
cations, Inc., Riverhead, L. I., N. Y.

2:00 P.M.—4:00 P.M.—Ballroom

"The DuMont Television System", by
T. T. Goldsmith, Jr., Allen B. DuMont
Laboratories, Inc., Passaic, N. J.

"Video Modulation Detection", by
W. S. Barden, RCA License Laboratory,
New York, N. Y.

"RCA-NBC Television Mobile Units",
by John Evans, C. H. Vose, RCA Manu-
facturing Company, Inc., Camden, N. J.,
and H. P. See, National Broadcasting
Company, New York, N. Y.

"Wide-Band Amplifiers for Tele-
vision", by H. A. Wheeler, Hazeltine
Service Corporation, New York, N. Y.

"A Theoretical Analysis of Single-
Side-Band Operation of Television
Transmitters", by L. S. Nergaard, RCA
Manufacturing Company, Inc., Harri-
son, N. J.

SEARCHLIGHT SECTION

EMPLOYMENT : BUSINESS : OPPORTUNITIES : EQUIPMENT—USED or RESALE

UNDISPLAYED RATE:
10 cents a word, minimum charge \$2.00.
Position Wanted, (full or part-time salaried employment only), 1/2 the above rates, payable in advance.
Proposals, 40 cents a line an insertion.

INFORMATION:
Box Numbers in care of our New York, Chicago, or San Francisco offices count 10 words additional in undisplayed ads. Replies forwarded without extra charge.
Discount of 10% if full payment is made in advance for four consecutive insertions of undisplayed ads (not including proposals).

DISPLAYED—RATE PER INCH:
1 inch.....\$6.00
2 to 3 inches..... 5.75 an inch
4 to 7 inches..... 5.50 an inch
An advertising inch is measured vertically on one column, 3 columns—30 inches—to a page. *Contract rates on request.*

(New advertisements must be received by June 27th for the July issue)

(POSITION WANTED)
INQUIRY
Electrical engineer, radio experience, desires contact or interview, leading to eventual employment, with airline or manufacturer of airways radio equipment. Employed at present, in important technical capacity, by large Eastern electrical manufacturer. Several important disclosures to present employer. Associate, IRE. Age, 27. Full information upon request. Address PW-149, ELECTRONICS 330 West 42nd St., New York City

POSITION WANTED
LICENSED RADIOTELEPHONE OPERATOR, first class. One year of college, operating experience, experience in Cathode-Ray development laboratory. Desires an opportunity for service with a progressive company. L. E. Will, 503 Chestnut St., Saint Mary's, Penna.

FOR SALE
TABLE OF CIRCUIT CONSTANTS reference sheet this month. Large type, four heavy notebook punched pages. Price fifty cents postpaid. Henry R. Hesse, 3119 Clarendon Road, Brooklyn, N. Y.

YOUR ORGANIZATION
*Is it complete?
Are you expanding it?
Making replacements?*
Naturally, you are anxious to secure the most suitable man or men available. You want men with the special training that will make them an asset to your organization. You can contact such men through a Position Vacant advertisement in the Searchlight Section of ELECTRONICS

QUARTZ
Quartz or Glass Apparatus—Gaseous Discharge Tubes of all descriptions.

Built to your specifications. We number among our customers America's largest manufacturers of Ultra Violet Equipment.

HYDE TECHNICAL LABORATORIES
1140 Venice Blvd., Los Angeles, Calif.

DEPENDABLE
New and Used
ELECTRONIC TUBE EQUIPMENT
A complete line of equipment for the manufacture of Radio Tubes, Neon Tubes, Incandescent Lamps, etc.
Write for Bulletin showing savings from 25 to 75%
EISLER ELECTRIC CORP.
534 39th Street, Union City, N. J.

METERS REPAIRED, TESTED, REBUILT
Specialists on all makes and types
Designers and Manufacturers of Special Equipment and Devices
Used Meters Bought, Sold, Exchanged
Correspondence invited
Associated Research, Inc.
16 N. May Street CHICAGO, Illinois

Meters repaired, made more serviceable. Conversion to higher sensitivity as high as 10 microamperes for Weston type I or 24-57.
Sensitive vacuum thermo-couples
For Sale used Weston panel meters. Rawson microammeters, Brown pyrometers.
Reasonable Prices
Precision Electrical Instrument Co.
561 Broadway, N. Y. C.

SPECIAL
ELECTRONIC EQUIPMENT
Designed and built to meet your particular requirements. High quality material and workmanship.
We invite your correspondence
MARKLI ENGINEERING CO.
128 Market Street Annapolis, Md.

COMPLEX ELECTRONIC DEVICES
PLAYING IMPORTANT INDUSTRIAL ROLES
The Altec Service Corporation, an organization composed of scientists, engineers and practical technicians, offers a dependable nation-wide organization for servicing all electronic equipment, such as photo-electric cell devices, sound transmission apparatus and industrial vacuum tube applications generally. Altec now services 5000 theatres and radio stations. Altec Service Corporation, 250 West 57th Street, New York City.



CHAS. EISLER'S
Equipment
Has Produced
MILLIONS
FOREMOST IN THE ELECTRONICS FIELD FOR OVER 20 YEARS!
Charles Eisler's equipment for the production of radio and electronic tubes, incandescent lamps, X-ray and cathode ray tubes, photo-electric cells, mercury switches, and neon signs has met the severest demands of industry in operating at the lowest cost and highest efficiency. If you are in the market for any of this or allied equipment including electric spot welders up to 250 KVA, butt, and arc welders, get in touch with us. Write for our "college and glass working laboratory units" catalog if interested in equipment for instruction purposes.
750 S. 13th St. (Near Avon Ave.) **EISLER ENGINEERING CO.** Newark, N. J.

CORNELL-DUBILIER
CAPACITORS
MICA • PAPER
DYKANOL
ELECTROLYTIC
FOR INDUSTRIAL AND ALL OTHER APPLICATIONS WE STOCK ALL TYPES
WRITE FOR CORNELL-DUBILIER CATALOG
CAMERADIO
963 LIBERTY AVE. • 30 TWELFTH ST.
PITTSBURGH PA. WHEELING, W. VA.
Established 1919

SOLENOID COUNTERS

New four-wheel counters—1300 ohm 24-48 v. d. c.
These counters have many applications in photo-electric cell work, broadcasting stations, and industrial uses. Original cost \$8.50; while limited stock lasts, \$2.00 each; 3 for \$5.00. C.O.D. only. Perfect cond. guaranteed or money refunded.
FEDERAL SALES COMPANY
26 S. Jefferson St. CHICAGO, ILL.

radio equipment..
for **Broadcasting Stations**
Engineers
Laboratories
Call or Write
TERMINAL
Radio Corporation
80 Cortlandt Street, New York, N. Y.

HIGH GRADE NEW AND USED
ELECTRON TUBE EQUIPMENT
Huge Stock of Equipment of Every Type and Variety
KAHLE ENGINEERING CORPORATION
Specialists in Equipment and Methods for the Manufacture of Neon Tubes, Radio Tubes, Incandescent Lamps, Photo Cells, X-ray Tubes, etc.
941 DeMott St., North Bergen, N. J.

VACUUM THERMOCOUPLES
Separate Heater and Contact Types, Mounted and Unmounted
Ranges from 1 Milliamp and up
Write for Bulletin "A"
American Electrical Sales Co. Inc.
65-67 E. 8th St., New York, N. Y.



LIVE - RUBBER MOLDED CONDENSERS

● For years AEROVOX engineers have sought higher leakage resistance and breakdown voltage in paper condensers for critical functions. Phenolic resin molded units were tried and rejected as far back as 1930. Likewise other jacketing means. But now—Eureka! It's the live-rubber molded paper condenser 88 series.

Check these features . . .

- ✓ Selected paper section molded in live rubber. Moisture cannot penetrate. Casing fits snugly around pigtail leads.
- ✓ No moisture released during vulcanizing process. Unit cannot absorb moisture during production.
- ✓ Molding done at temperature below that of vacuum impregnation cycle of section. Section cannot be impaired.
- ✓ No excessive pressure during molding, as contrasted with phenolic resin molding. Section remains unchanged.
- ✓ Tests indicate insulation resistance and breakdown voltage far exceeding phenolic resin molded units.
- ✓ Available in capacities up to .25 mfd. in 200-volt, .1 in 400-volt, .05 in 600-volt, and .01 in 1000-volt.

Ask for DATA . . .

- Complete technical information including charts and graphs, sent on request. Likewise sample to parties writing on business letterhead. Quotations also.



INDEX TO ADVERTISERS

| | |
|--|------------|
| Acheson Colloids Corp. | 76 |
| Aerovox Corp. | 96 |
| Allied Controls, Inc. | 72 |
| Allied Recording Products Co. | 68 |
| American Automatic Electric Co. | 68 |
| American Brass Co. | 94 |
| American Emblem Co. | 8 |
| American Screw Co. | 2 |
| American Transformer Co. | 51 |
| Amperex Electronics Products, Inc. | |
| Inside Front Cover | |
| Astatic Microphone Laboratory, Inc. | 93 |
| Audak Co. | 76 |
| Ballentine Labs., Inc. | 84 |
| Biddle Co., James G. | 82 |
| Bliley Electric Corp. | 84 |
| Boonton Radio Corp. | 77 |
| Brand & Co., William | 83 |
| B-L Elec. Mfg. Co. | 87 |
| Callite Products Division | 92 |
| Cannon Elec. Development Co. | 74 |
| Carter Motor Co. | 88 |
| Centralab Div., Globe-Union Co. | 61 |
| Cinch Manufacturing Co. | 7 |
| Continental-Diamond Fibre Co. | 6 |
| Continental Electric Co. | 72 |
| Continental Screw Co. | 2 |
| Corbin Screw Co. | 2 |
| Cornell-Dubilier Elec. Corp. | 5 |
| Cornish Wire Co. | 79 |
| Daven Co. | 69 |
| Davis & Co., Dean W. | 78 |
| Doolittle & Falknor | 85 |
| Drake Mfg. Co. | 79 |
| Driver Co., Wilbur B. | 85 |
| Du Mont Laboratories, Inc., Allen B. | 87 |
| Ecco High Frequency Labs., Inc. | 82 |
| Electrovox Co. | 72 |
| Erie Resistor Corporation | 66 |
| Fairchild Aerial Camera Corp. | 52 |
| Ferranti Electric, Inc. | 46 |
| Ferrocarril Corp. (f America | 85 |
| Finch Telecommunications Labs, Inc. | 81 |
| Goat Radio Tube Parts, Inc. | 58 |
| Guardian Elec. Corp. | 86 |
| Hammarlund Mfg. Co., Inc. | 86 |
| Heintz & Kaufman, Ltd. | 93 |
| Hunter Pressed Steel Co. | 77 |
| International Nickel Co., Inc. | 57 |
| International Resistance Co. | 43 |
| Isolantite, Inc. | 47 |
| Jones, Howard B. | 81 |
| Kenyon Transformer Corp. | 71 |
| King Laboratories, Inc. | 83 |
| Leach Relay Co. | 79 |
| Lenz Electric Co. | 4 |
| Lingo & Son, Inc., John E. | 3 |
| Mallory & Sons, P. R. | 10 |
| McGraw Hill Book Co. | 75, 93 |
| Monarch Mfg. Co. | 78 |
| National Carbon Co. | 54 |
| National Screw | 2 |
| Ohmite Manufacturing Co. | 62 |
| Onan & Sons, Inc., D. W. | 86 |
| Oxford-Tartak Corp. | 74 |
| Parker-Katon Corp. | 2 |
| Phillips Screws | 2 |
| Pioneer Gen-E-Motor Corp. | 75 |
| Post Co., Frederick | 50 |
| Precision Resistor Co. | 74 |
| Presto Recording Corp. | 73 |
| Radio Corporation of America | 63 |
| Radiotone, Inc. | 64 |
| Raytheon Mfg. Co. | 81 |
| RCA Communications, Inc. | 78 |
| RCA Manufacturing Co. | Back Cover |
| Remler Co., Ltd. | 88 |
| Richardson Co. | 82 |
| Russell, Burdell & Ward Bolt & Nut Co. | 2 |
| Shure Brothers | 90 |
| Simpson Electric Co. | 94 |
| Sigma Instruments, Inc. | 94 |
| Speer Carbon Co. | 65 |
| Stackpole Carbon Co. | 9 |
| Standard Transformer Corp. | 91 |
| Superior Tube Co. | 48, 49 |
| Sun Radio Co. | 96 |
| Synthane Corp. | 53 |
| Triplett Electrical Instrument Co. | 89 |
| Ward Leonard Electric Co. | 56 |
| Western Electric Company | 45 |
| Weston Elec'l Instrument Corp. | 55 |
| Whisk Laboratories | 96 |
| White Dental Mfg. Co., S. S. | |
| Inside Back Cover, | 92 |
| Zophar Mills | 84 |
| Professional Services | 89 |
| SEARCHLIGHT SECTION | |
| Classified Advertising | |
| EMPLOYMENT | 95 |
| QUARTZ OR GLASS APPARATUS | 95 |
| SERVICE | 95 |
| EQUIPMENT FOR SALE | |
| American Electrical Sales Co., Inc. | 95 |
| Associated Research Inc. | 95 |
| CameRadio Co. | 95 |
| Eisler Electric Corp. | 95 |
| Eisler Engineering Co. | 95 |
| Federal Sales Co. | 95 |
| Kahle Engineering Corp. | 95 |
| Markli Engineering Co. | 95 |
| Precision Electrical Instrument Co. | 95 |
| Terminal Radio Corp. | 95 |

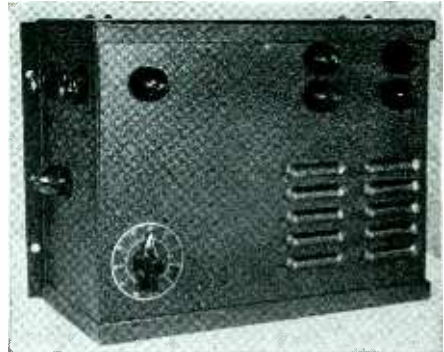

Balancing and Semi-Tuned Power Filters for All Power, Ignition and Antenna Circuits.

Units available for: Airplanes, airships, marine ships, fighting tanks, police radio, government and industrial research laboratories, colleges and many other uses.

- No shielding required
- Available in various capacities
- Light in weight
- Easy to install
- Efficient
- Inexpensive

Write for descriptive literature with prices.

SAMUEL M. WHISK, Owner
Manufacturers

WHISK LABORATORIES

145 West 45th St., New York, N. Y.
Bryant 9-5346

IT'S GREAT TO MEET A FRIEND FROM THE OLD HOME TOWN . . .

. . . and you will have as great pleasure when dealing with the Sun Radio . . . one of the oldest and largest parts stores in New York.

A large selection of parts required in electronic developments and manufacture as well as for Broadcast Stations are always in stock; for example—sensitive and standard relays, photo electric cells, meters, condensers, resistors, receiving, special purpose and transmitting tubes, in fact, practically all standard nationally advertised parts.

Let us prove to you how promptly and accurately we can fill your order.

The following are a few of the lines we carry
Aerovox, Astatic, Gardwell, Cornell
Dubilier, C. R. L., Eby, Hammarlund, I. R. G.,
Jones, Plugs, Johnson, National, Ohmite, Pyrex,
Shallcross, Thordarson, Trimm, Yaxley,
Mallory, Ward-Leonard, Guardian, Leach,
Clough-Brenigle, Dumont, Hickok, Supreme,
Triplett, Weston, Amperex, Raytheon, RCA,
Taylor, Eimac, Gammatrone.



Study this principle of transmitter design --- it's good for home radios too!

The RCA 250-D Broadcast Transmitter presents an outstanding example of how *utmost operating convenience can be obtained without sacrifice of electrical circuit efficiency* by the use of S. S. WHITE Remote Control Flexible Shafting.

The illustrations and the following quotation from RCA's 250-D Transmitter Bulletin, tell the story:

"In some transmitters, tuning elements are rigidly coupled to controls on the panel. Thus, if tuning condensers and variable inductances are located with respect only to their position in the circuit, the corresponding controls are unsymmetrically arranged and scattered about the panel, while, if the latter are arranged symmetrically, the tuning components are more or less out of place in the circuit. In the 250-D transmitter, flexible shaft couplings are used in order to allow grouping of all controls on a single conveniently placed panel. This makes it possible to mount all condensers, coils, etc., *in the optimum position with respect to the circuit, and yet have all the controls on a single small panel.*"

(The italics are ours.)

Obviously, the use of flexible shafting offers the same advantages for home radios. It allows unrestricted freedom in both electrical circuit and cabinet design, and full latitude in positioning controls.

Full details about S. S. WHITE Flexible Shafting for Remote Control and "coupling," are given in ENGINEERING BULLETIN 38. Write for a free copy —today.

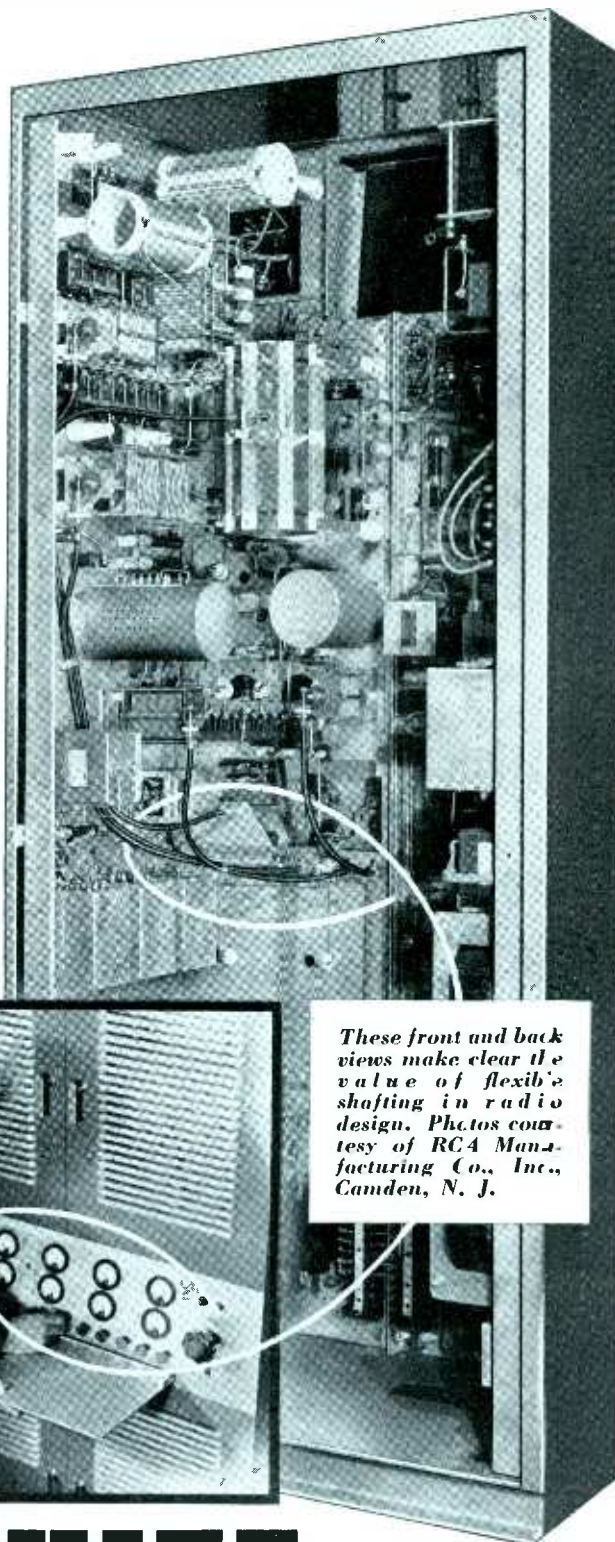

These front and back views make clear the value of flexible shafting in radio design. Photos courtesy of RCA Manufacturing Co., Inc., Camden, N. J.

S. S. WHITE

The S. S. White Dental Mfg. Co.

INDUSTRIAL DIVISION

10 East 40th St., Room 2310E, New York, N. Y.

*Improved
Performance*

**with the new
6K8 Metal
Converter
Tube**

New tube for use in all-wave radio receivers shows definite superiority over other converter types for short-wave reception . . .

The RCA 6K8 is a multi-unit type of metal vacuum tube which incorporates a triode unit and a hexode unit. The triode unit is capable of unequalled oscillator performance. When used in all-wave receivers, this new tube provides excellent frequency stability in the high-frequency band. In AC-DC receivers, it gives exceptional performance on a plate supply of only 100 volts.

These are but a few of the RCA 6K8's many features that prove its value. For full details, write to the RCA Manufacturing Company in Harrison, N. J.

RCA presents the Magic Key every Sunday, 2 to 3 P.M., E. D. S. T. on the NBC Blue Network

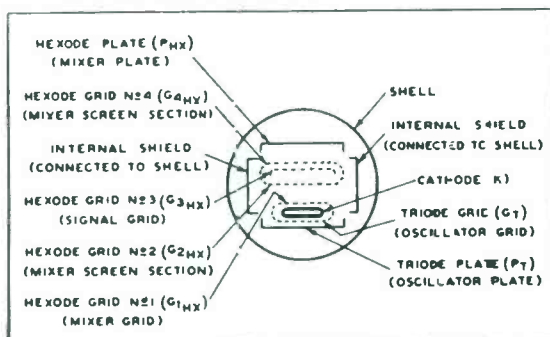

Above is shown Schematic Diagram of Electrode Structure in the new RCA 6K8



Radiotrons

RCA MANUFACTURING COMPANY, INC. • HARRISON, NEW JERSEY
A SERVICE OF THE RADIO CORPORATION OF AMERICA